

Prestressed Concrete Girder B8

FRILO Software GmbH

www.friilo.com

info@friilo.com

As of 05/12/2016

System input

- Basic data
- Cross-section
- Cast-in-place
- Erection State
- Concrete
- Prestressing steel
- Reinforcing steel
- Recesses
- Bearings
- Remarks

Load input

- Loads
- Sections
- Lateral buckling
- Optional settings
- Remarks

Output

- Output settings
- Word
- Screen
- Printer
- Print Preview

Basic data | Cross-section | Cast-in-place | Erection State | Concrete | Prestressing steel | Reinforcing steel | Recesses | Bearings | Remarks

Code
BS EN 1992:2015

Installed state
LSP= 20.00 m LCL= 0.10 m
LCR= 0.10 m

Deformation
quasi-perm. combination
btm:>XC1
top:>XC1
c= 3.3 cm **Durability**

Girder type
Type: Double-pitch roof
hle= 120.0 cm
hRidge= 180.0 cm xR= 10.10 m
hi= 120.0 cm

Cast-in-place
Type: none
dp= 0.0 cm
DB1= 0.00 m
DB2= 0.00 m

Floor loading
g0= 0.00 kN/m² q0= 0.00 kN/m² Vehicle load < 30kN
Fac= 1.00 s0= 0.00 kN/m² Snow loads < 1000m

OK Cancel << >>

Number of bars <= 3 01.12.2016 12:10

B8 – Prestressed Concrete Girder

Note: The present document describes the **Eurocode-specific application**. Documents referring to former standards are available in our document archive at www.friilo.eu >> Service>>Documentation >>Manuals.

Contents

Application options	5
Basis of calculation	7
Overview of standards	7
Verifications	8
Definition of the structural system	9
First steps	9
Basic data	11
Cross section	13
Cast-in-place concrete	15
Erection	17
Concrete	18
Concrete properties	18
Shrinkage and creep	19
Prestressing steel	21
Prestressing steel definition	22
Reinforcing steel	24
Reinforcing steel definition	25
Recesses	26
Bearings	27
Loads	28
Self-weight	30
Sections	30
Lateral buckling	32
Optional settings	33
Calculate	34
Output	35
Output of the calculation results	35
Utilization	36
Adviser	37
Output settings	39
Text view	39
Selection of the degree of prestressing and suitable reinforcement	41
Reference literature	42

Further information and descriptions are available in the relevant documentations:

[Durability - Creep Coefficient and Shrinkage Strain.pdf](#)"

[B8-Nachweis.pdf](#) (verifications, in german)

FDC – Basic Operating Instructions	General instructions for the manipulation of the user interface
FDC – Menu items	General description of the typical menu items of Frilo software applications
FDC – Output and printing	Output and printing
FDC - Import and export	Interfaces to other applications (ASCII, RTF, DXF ...)
FCC	Frilo.Control.Center - the easy-to-use administration module for projects and items
FDD	Frilo.Document.Designer - document management based on PDF
Frilo.System.Next	Installation, configuration, network, database

Abbreviations used in this document:

EN 1992-1-1:	EN2
DIN EN 1992-1-1/NA:	NA_D
PN EN 1992-1-1/NA:	NA_PN
ÖNORM B 1992-1-1	NA_A
NA to BS EN 1992-1-1	NA_GB

Application options

The software application allows you to verify concrete girders that were pre-tensioned in a stressing bed and/or individual cross sections in accordance with the following standards:

- DIN EN 1992-1-1/NA 2015-12 Germany
- PN EN 1992-1-1/NA:2010 Poland
- ÖNORM B 1992-1-2:2011-12-01 Austria
- NA to BS EN 1992-1-1/A2:2015-07 Great Britain
- EN 1992-1-1 2004/A1:2014 Eurocode, NDP with recommended values

Former versions (DIN...) still available.

Girder types

- Girders with parallel flanges
- Symmetrical girders with saddle or groove
- Asymmetrical girders with saddle or groove
- Single-pitch roof girders

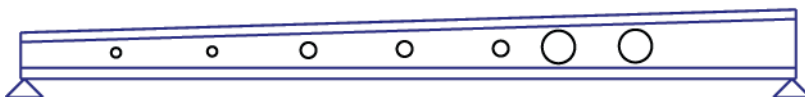
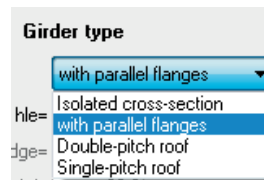

Shapes of cross sections

- Rectangular
- T-girder with one or two webs
- General cross sections (simple symmetrical)
- Optionally with cast-in-place concrete complement
- With up to 10 recesses
- With bearing reinforcements

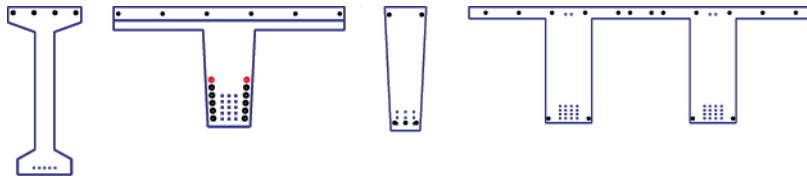

Structural systems

- Single-span girder with/without cantilevers
- Separate systems for the installed state and the erecting states
- Auxiliary supports for the pouring of the cast-in-place complement

Loading (mainly static, uniaxial without torsion)

- Uniform linear loads
- Concentrated loads
- Concentrated moments
- Trapezoidal loads

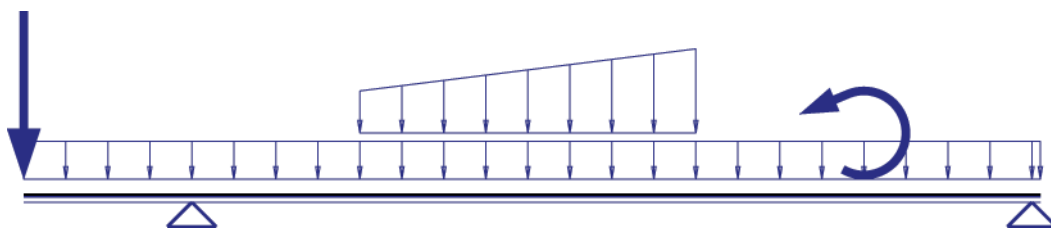

Reinforcement

- Multi-layer pre-tensioned reinforcement, optionally with insulation
- Multi-layer untensioned reinforcement
- Straight run of the reinforcement in parallel to the top and/or bottom flange

Limitations

- No consideration of recesses in the verification of shear resistance
- No calculation of the through-reinforcement for the flange connections

Basis of calculation

You can examine and verify the girder either on freely selectable cross sections or via the automatic processing of a set of sections determined with the help of a grid.

At the point of examination, the corresponding cross section is generated in line with the shape of the girder, existing recesses, bearing reinforcements and cast-in-place complements.

Subsequently, the beginning and the end of the creep stages defined for the girder are examined. In this examination, the actions active at that time are examined on the effective structural system in each case.

The pretension effective in the point of examination (load transfer area, stripped insulation) and at the time of examination is taken into account. In this examination, the loss from creep and shrinkage is determined with the help of previously calculated creep factors and shrinkage strains and with consideration of the reinforcement portions. In addition, losses due to relaxation of the prestressing steel are taken into account.

To ensure sufficient stability in the ultimate limit state, the following analyses are performed:

- Bending with longitudinal force
- Shear force
- Lateral buckling
- Calculation of the tensile splitting reinforcement
- Anchorage of the prestressing reinforcement

To ensure sufficient serviceability of the component, the following analyses are performed:

- Reinforcing steel and prestressing steel stresses
- Crack width, possibly decompression
- Deflections

You can verify components with untensioned reinforcement or with a freely selectable degree of prestressing.

Overview of standards

Abbreviated title	Standard for the load combinatorics	Design standard	Additional standards
EN2	EN 1990:2002/AC:2010	EN 01/01/1992: 2004/A1: 2014	Prestressing steel: pr EN 10138 Reinforcing steel: EN 10080
NA_D	DIN EN 1990/NA:2010-12	DIN EN 1992-1-1/ NA:2015-12	Prestressing steel: approval Reinforcing steel: DIN 488
NA_A	ÖNORM B 1990-1 2013-01-01	ÖNORM B 1992-1-1: 2011-12-01	Prestressing steel: ÖNorm B 4758:2011 Reinforcing steel: ÖNORM B 4707: 2014
NA_PN	PN EN 1990/NA:2010	PN-EN 1992-1-1: 2008/NA:2010	= EN2
NA_GB	NA to BS EN 1990/ A1:2009-06	NA to BS EN 1992-1-1/ A2:2015-07	Prestressing steel: BS 5896 [2012] Reinforcing steel: BS 4449:2005 A3:2016 Durability: BS 8500-1:2015

Verifications

The documentation for the verifications and output examples can be found on our homepage in the document ▶ [B8-Nachweis.pdf](#) (in german).

Prestressing steel

The default prestressing steel type is the 1570/1770 (NA_D) strand or Y1770S7 (NA_PN, NA_A, NA_GB, EN2). The load-transfer length is determined by the specifications of the prestressing steel approval/standard of prestressing steel and shall be entered accordingly (prestressing steel dialog). The disturbing length is automatically adjusted to the girder height at the girder front end or rear end. It can also be set by the user.

The table of the prestressing steel layers indicates the roughly calculated number of prestressing steel strands. You should define the loads before-hand. You can find more information about the pre-design in the chapters "Prestressing Steel" and "Selection of the Degree of Prestressing". The run of the prestressing steel strands over the length of the girder is automatically adjusted to changes in the girder length.

Reinforcing steel

Above the table with the reinforcing steel layers, a roughly calculated lower concrete reinforcement due to robustness requirements or resulting from bending design is displayed. Previously defined prestressing steel is considered. The run of the reinforcing steel bars over the length of the girder is automatically adjusted when you change the girder length.

Sections

The number of sections of the basic grid allows you to control the accuracy of the calculation of the critical sections and the deflections. If you have defined larger cantilevers, make sure that a sufficient number of sections lie on these cantilevers. You can find more information in the chapter "Sections".

Verifications

You can gain a quick overview over the successful verifications via the utilization window (Utilization item in the main menu). The main menu item "Adviser" allows to access information on how to modify the girder if verifications have been unsuccessful.

More detailed information is available in the graphical representations and tables about the behaviour of the verified entities.

The extensive output on selected sections provides intermediate results for a targeted manual calculation.

Basic data

Select the desired standard for the calculation:

Basic data	Cross-section	Cast-in-place	Erection State	Concrete	Prestressing steel	Reinforcing steel	Recesses	Bearings	Remarks
Code BS EN 1992:2015	Girder type Type: Double-pitch roof hle= 95,0 cm hRidge= 170,0 cm xR= 15,15 m hri= 95,0 cm	Cast-in-place Type: none dp= 0,0 cm DB1= 0,00 m DB2= 0,00 m	Installed state LSP= 30,00 m LCL= 0,15 m LCR= 0,15 m	Floor loading g0= 0,00 kN/m ² Fac= 1,00	q0= 0,00 kN/m ² s0= 0,00 kN/m ²	Vehicle load < 30kN Snow loads < 1000m	Deformation: quasi-perm. combination btm:XC1 top:XC1 c= 2,8 cm Durability		
<input type="button" value="OK"/> <input type="button" value="Cancel"/> <input type="button" value="<<"/> <input type="button" value=">>"/>									

Installed state (system length)

For the storage and installed states, the span width LSP as well as the lengths of the left and right cantilevers or projections shall be specified. With asymmetrical saddle-roof girders, you must specify the location of the ridge point x1 in addition.

LSP span length

LCL length of left cantilever

LCR length of right cantilever

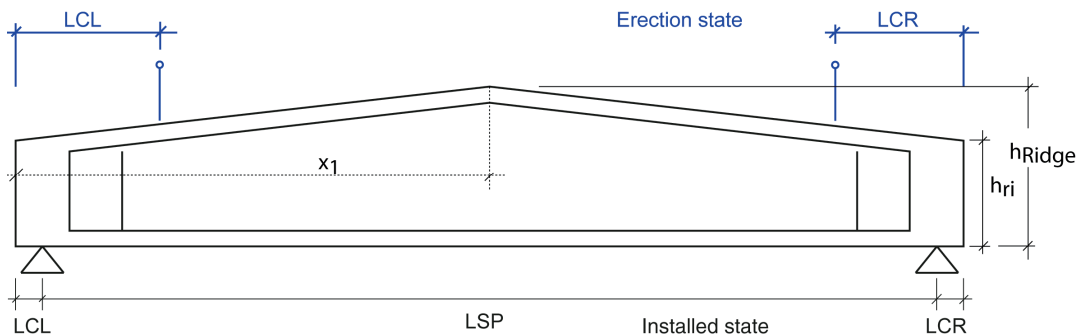

Deformation

Selection of the load combination of the SLS to be used in the deformation calculation.

Especially when physical reasons play a role in addition to aesthetical criteria (e.g. protection of partition walls or glass facades) or when variable loads would not be considered because of $\psi_2 = 0$, it might be required to assume a less favourable load combination than the quasi-permanent combination specified in 7.4.1 (4). (DIN EN 1990, A1.4.3 (1)).

Note: In Alpine regions with long-term snow you should select the quasi-permanent load combination instead of the infrequent load combination and enter a user-defined snow action, in order to ensure that creep is taken into account with the full creep factor.

Durability

When you set up a new item, the durability dialog is displayed after you have selected the appropriate standard. In this dialog, the parameters to ensure durability are set.

► See also [Durability - Creep Coefficient and Shrinkage Strain.pdf](#).

The durability requirements are as follows:

- The minimum concrete cover for stirrups, reinforcing steel and prestressing steel
- The minimum concrete class
- The permissible crack width and the load combination for the verification of the crack width
- The necessity to verify the decompression resistance and the load combinations for this verification

You can access this dialog also via the  button.

Nominal thickness of the concrete cover c_{nom}

c_{nom} results from the maximum of $c_{p,nom}$ (prestressing steel) and $c_{s,nom}$ (reinforcing steel).

Girder type

Type individual cross section (instead of a girder, a cross section is verified)

Parallel flange girder

Double-pitch roof girder

Single-pitch roof girder

hle girder height at the front end (left)

hridge girder height at the ridge (only with double-pitch roof girders)

hri girder height at the rear end (right side) - only in combination with double-pitch and single-pitch roof girders

x1 distance of the ridge point from the left edge

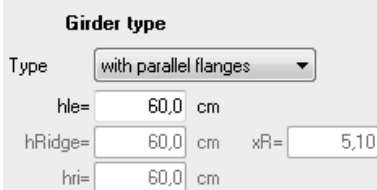
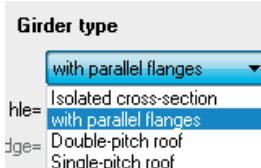
Cast-in-place complement

► See the chapter [Cast-in-place concrete](#).

Floor loading

Area loads acting on the cast-in-place concrete floor

g0 permanent portion in [kN/m²]

q0 variable portion in [kN/m²]

Actions as per category A, B or G. The drop-down list to the right allows the assignment (default: "living rooms" or for NA-D: "Other variable actions")

s0 snow load in [kN/m²] (snow load action group).

Selection options: up to 1,000 m or above 1,000 m

continuity factor for the continuity effect, by which the loads will be multiplied,

► see continuity factor in the chapter [Cast-in-place concrete](#).

Cross section

Click on the cross section button to access the cross-section selection dialog.

Select among the cross-section shapes "Rectangle", "Top flange", "Layer" and "Pi-plate" and specify the corresponding dimensions (the dimensions are shown on the graphic screen).

For girders with a saddle or groove, the cross section at the ridge is defined. For single-pitch roof girders, the cross section at the right end is defined.

Rectangle define the width (b) and the thickness (d)

T-girders

Top enter the dimensions hft, bft, h and b as shown in the illustration.

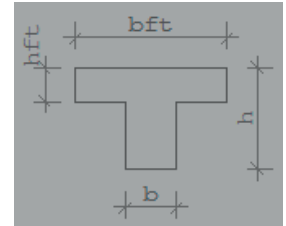

Layers enter the distance (0 = top of the cross section) and width in [cm]. In the "web" column, define the web front end or the web rear end.

The cross section must be symmetrical along the vertical axis. Segregate it in mind into individual sections. Layer borders are points of discontinuity in the cross-sectional width.

The first layer always has the distance 0. For each layer, the width and distance to the top edge of the cross section shall be specified. At cross-section jumps, two layers with the same distance but different widths shall be defined. 20 layers maximum can be defined.

The width of the layer is constant over the length of the girder.

The width of the layer that is marked as the front end of the web is equal to the web width. With the specification of the front end and rear end of the web, the top flange and bottom flange are defined too.

For girders with a variable height, the layers above the bottom flange are assumed to have the same inclination as the top edge; layers in the bottom flange are always horizontal.

Layers in the web of a girder with variable height must have the same width; otherwise, no plane formwork surfaces will be obtained.

The top and bottom flanges may only intersect outside of the girder and/or in the area of a bearing reinforcement, if at least one flange forms a rectangle with the reinforced web at this point.

Pi-plate Same parameters as T-girder plus the distance of the two webs "lw".

[cm]	Distance	Width	Web
1	0,0	55,0	<input type="checkbox"/>
2	16,0	55,0	<input type="checkbox"/>
3	24,5	12,0	<input checked="" type="checkbox"/>
4	151,5	12,0	<input checked="" type="checkbox"/>
5	165,0	30,0	<input type="checkbox"/>
6	180,0	30,0	<input checked="" type="checkbox"/>

X for web start/end

Dimensions [cm]	
Name	Pi plate
Top flange	
bft =	0,00
hft =	0,00
Web	
b =	30,00
h =	60,00
lw =	0,00

Options

- Height top flange constant
- Height web constant

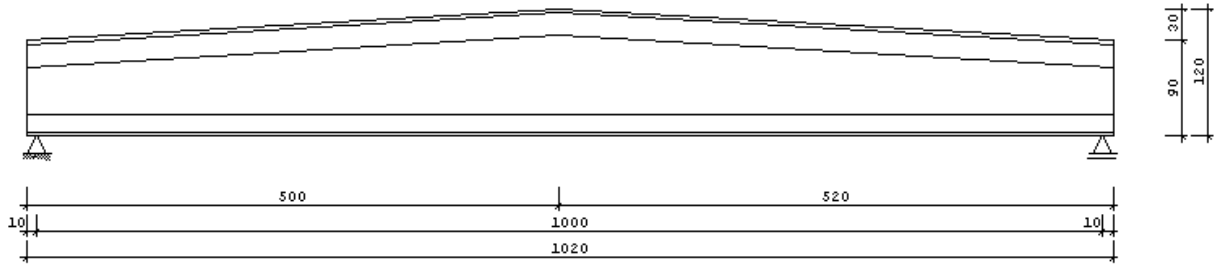
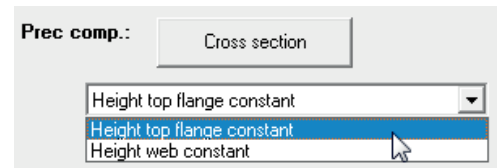

III.: *Constant top flange: the thickness of the top flange is constant over its total length.*

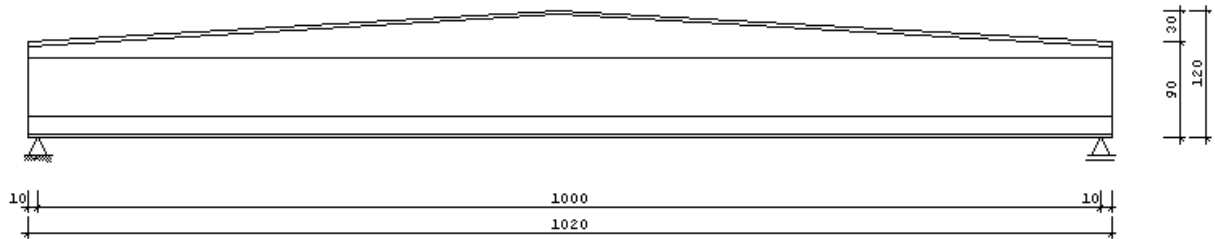

III.: *Constant web height: the height of the webs is constant, the thickness of the top flange varies over its length.*

Cast-in-place concrete

Cast-in-place complement

Type no cast-in-place complement, solid slab, solid slab with prefabricated formwork, additional layer, additional layers.

dp thickness of cast-in-place concrete slab.
 The thickness of the cast-in-place concrete slab is assumed constant over the total length of the girder.

Cast-in-place addition	
Type	none
	none
	Concrete slab
	Concrete slab with formwork
	Additional layer
	Additional layers

Cast-in-place addition	
	Concrete slab with formwork
dp=	10,0 cm
DB1=	5,00 m
DB2=	5,00 m

Solid slab:

The cross section of the cast-in-place concrete consists of a solid slab between two adjacent girders. Their distance DB1 (left) and DB2(right) to the current girder and the thickness (dp) of the cast-in-place concrete layer shall be defined.

▶ see the illustration below.

DB1 girder spacing on the left

DB2 girder spacing on the right

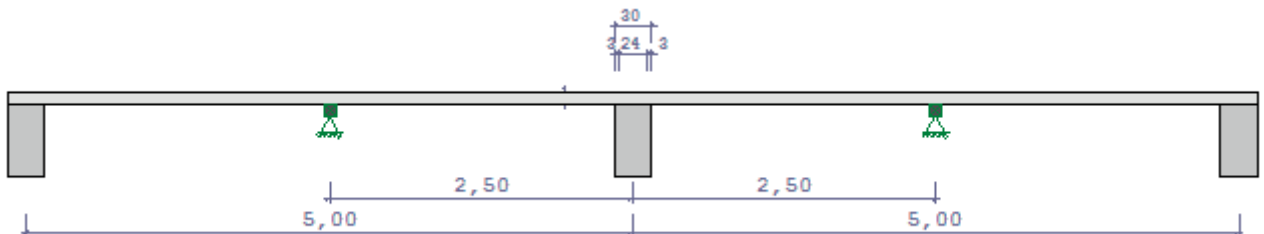

Note: Unequal distances to the adjacent girders will produce a highly asymmetrical cross section which must be designed for oblique bending and possibly also torsion. You cannot do this in this software application.

Solid slab with pre-fabricated formwork:

A precast slab with the thickness d is used as dead formwork that rests on the adjacent girders with a supporting length t .

d thickness of the pre-fabricated formwork

t supporting length (on the left and the right)

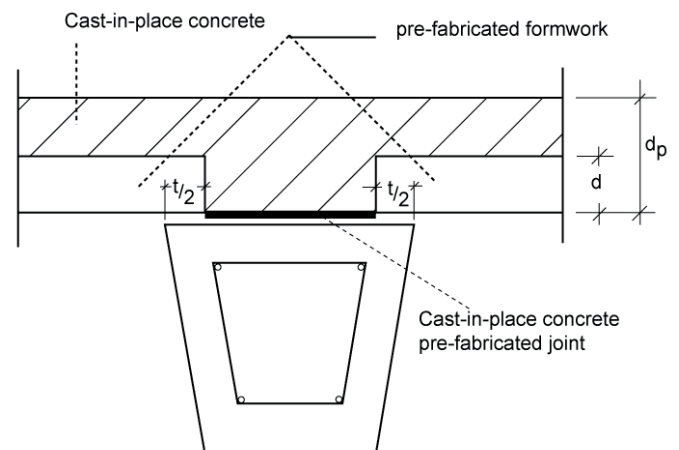

Additional layer:

Instead of DB1 and DB2, the width of the cast-in-place concrete layer shall be specified here, e. g. for twin-webbed slabs with cast-in-place concrete topping.

bp width of the cast-in-place concrete layer

Additional layers:

Definition of up to six layers as with the layered cross section for prefabricated components.

Effectively involved width with cast-in-place concrete complement

- Calculation: for each section, on the defined cross section or manual specification
- Manual specification:
- B1** effectively involved width to the left of the web (enabled for solid slab)
 - B2** effectively involved width to the right of the web (enabled for solid slab)
 - Beff** effectively involved width (enabled for additional layer or additional layers)

Joint

- Rough/interlocked** this option allows you to define the execution of the joint with or without interlocking. The execution of the joint has an influence on the verification of the shear cover of the cast-in-place concrete joint.

Additional load details

- Continuity factor** this factor allows you to take the influence of the continuity effect of the cast-in-place concrete self-weight and the top slab loads transverse to the girder direction into account after completion of the bond for cast-in-place concrete complements of the type "solid slab":

At an end support: factor = 0.375 ... 0.4

At an inner support: factor = 1.250 ... 1.1

With no support factor = 1.0

- Concreting load CL** the concreting load CL in [kN/m²] is a technological live load that applies only during the pouring of the cast-in-place concrete complement.
- In combination with the "solid slab" type, the loaded area is determined by the girder spacing and/or the formwork support, if applicable.

Erection

Structural system

For verifications in the erecting state, the distance to the erecting fastener shall be specified for LCL and LCR (lengths of the left and right cantilevers). Otherwise, LCL should be set to 0.

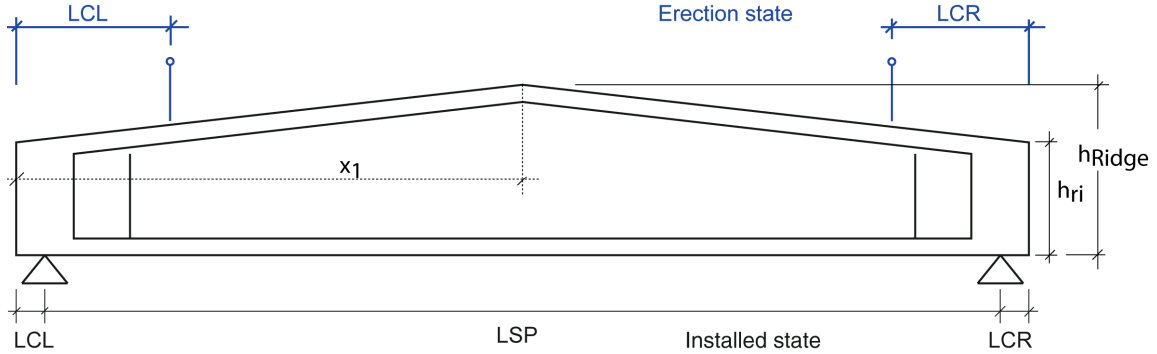

Auxiliary supports

The loading on the prefabricated component during the pouring of the cast-in-place complement can be reduced by defining supports of the girder or the formwork of the cast-in-place concrete slab. The load redistribution after the removal of the supports affects the complemented cross section.

Auxiliary support of girder

Available options are auxiliary supports in the "Mid of beam, the "Third points", "Continuous" or "No support".

It is assumed that the supports are placed underneath the girder that is deformed by its self-weight and pre-tensioning. This means that the weight of the cast-in-place concrete and, possible concreting load act on the supported girder.

Formwork support

If the cast-in-place concrete complement is a solid slab, the formwork can optionally be supported at a distance Dble (left) and Dbri (right) from the examined girder.

You can optionally select whether the support should be placed next to the girder or within the floor span. With supports within the floor span, the load width is determined by half the formwork distance to the left and the right ($Dble/2 + Dbri/2$), whereas, with supports next to the girders, the load width is equal to the width of the first cross section layer of the prefabricated component.

Formwork support

left from the girder	right from the girder
<input checked="" type="radio"/> none	<input checked="" type="radio"/> none
<input type="radio"/> besides the girder	<input type="radio"/> besides the girder
<input type="radio"/> in floor span	<input type="radio"/> in floor span

Distance of formwork supports :

Dble= m Dbri= m

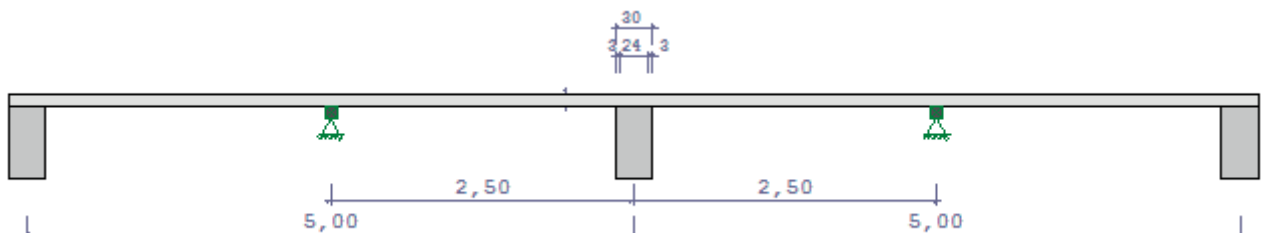

Concrete

For prestressed concrete, the minimum strength class specified in the approval shall be adhered to in accordance with 5.10.2.2.(3). Reference /52/ p. 63 recommends using C30/37 at least.

The software calculates automatically the following material parameters for the subsequent verifications:

- fcmt0	average compressive strength to the transferred tension force (t=t0)	Eq. 3.1
- fctk; 0.05	lower limit of the characteristic tensile strength	Table 3.1
- Ecm	mean value of the modulus of elasticity	Table 3.1
- Gcm	shear modulus derived from Ecm	
- perm. σ_c	(infrequent load combination)	7.2 (2)
- perm. σ_c	(quasi-permanent load combination)	7.2 (3)
- α_{cc}	coefficient to take the long-term effect into account (standard concrete: 0.85, lightweight: 0.75).	

 button accesses the concrete properties dialog.

Concrete properties

fck:	characteristic compressive cylinder strength								
fcmt0:	average compressive strength when removing the anchorage t0= tA,Lag is automatically calculated as per eq. 3.1. Optionally, a user-defined value can be specified.								
fckt0:	characteristic compressive resistance when untying the anchorage t0= tA,Lag Is automatically calculated in accordance with 3.1.2 (5). Optionally, a user-defined value can be specified.								
γ :	specific weight. Default: 25 KN/m ³								
α_e :	You can vary the modulus of elasticity of the concrete with the help of a coefficient that is determined in accordance with the aggregates used: <table border="0" style="margin-left: 40px;"> <tr> <td>Basalt</td> <td>1.2</td> </tr> <tr> <td>Quartz(ite)</td> <td>1.0</td> </tr> <tr> <td>Limestone</td> <td>0.8</td> </tr> <tr> <td>Sandstone</td> <td>0.7</td> </tr> </table>	Basalt	1.2	Quartz(ite)	1.0	Limestone	0.8	Sandstone	0.7
Basalt	1.2								
Quartz(ite)	1.0								
Limestone	0.8								
Sandstone	0.7								
k6(t0):	coefficient for the verification of the concrete stress at the time of the tensioning force application t0 = tA,Lag in accordance with 5.10.2.2 (5) EN2, NA_A, NA_PN, NA_GB: default value is 0.7 as per NA NA_D: default value is 0.6, 0.7 is permitted if particular prerequisites are met, see reference /52/ p. 63.								
γ_c (PT):	partial safety factors of the concrete for the permanent and transient design situations, default values in accordance with 2.4.2.4 (1) EN2, NA_A, NA_D, NA_GB: 1.5 NA_PN: 1.4								
γ_c (A):	partial safety coefficient of the concrete for the accidental design situation. default values in accordance with 2.4.2.4 (1) EN2, NA_A, NA_PN, NA_GB: 1.2 NA_D: 1.3								

Shrinkage and creep

Creep stages

Creep period	t ₀	LC	tT1	T1	tT2	T2	tT3	T3
Storage	3	70	0					
Usage precast								
Pouring in-situ	0							
Remove temp. support	0							
Usage precast+ supplement	180	50	0					

LAG	Storage
NUF	Usage precast
BOB	Pouring in-situ
ULH	redistribution due to removal of auxiliary supports
NUE	use/occupancy after adding the cast-in-place concrete complement

Creep-generating loads

G1	self-weight of prefabricated component
V	effective pretension
GE	self-weight of cast-in-place concrete
UL	loads from redistribution due to removal of auxiliary supports
G2	subsequent permanent loads on the completed cross section
P	quasi-permanent portion of variable loads

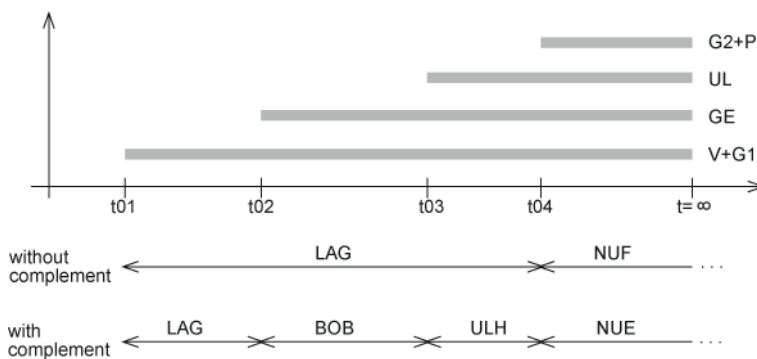

Definition of creep stages

For each creep stage, its beginning t_0 and the air humidity content LF shall be defined. The time t_0 refers to the commencement of the concreting work. When the ambient temperature differs considerably from 20 °C , you can define three stages maximum with the duration of $tT1$ to $tT3$ and the temperature $T1$ to $T3$. Otherwise, set $tT1$ to 0.

Creep stage "Storage"

Creep starts with the removal of the steel anchorage in the stressing bed. The pretension and the self-weight act as creep-generating stresses. The creep stage ends when additional permanent loads apply in the creep stages "Occupancy/use of prefabricated component" or "Pouring of the complement".

Creep stage "Occupancy/use of prefabricated component"



The creep stage starts with the application of the subsequent permanent loads $G2$ and ends at infinity (corresponds to 10,000 days as per DIN 4227, otherwise to 26,000 days). This creep stage does not apply to the cast-in-place complement, enter $t_0=0$.

Prestressing steel

Type of prestressing steel click on the  button to display the definition dialog for the prestressing steel type. →See „[Prestressing steel definition](#)“.

Note

The pre-design is displayed above the definition table.

Basic data	Cross-section	Cast-in-place	Erection State	Concrete	Prestressing steel	Reinforcing steel	Recesses	Bearings	Remarks
Prestressing type: Y1770S7 									
Preliminary design at x1= 7,48 m, req. Ap= 10,23 cm ² => 11 Prestressing steels									
	Number per layer	Flag	Dist.	Pre-stressing	isolated	to x left	from x right	parallel	
1	6	1	4,5	1022,00	2	0,30	19,70	1	
2	6	1	8,3	1022,00	2	0,30	19,70	1	

Number of prestressing elements per layer

The required number of prestressing elements is roughly calculated on the section with the maximum edge stresses under full loading in the installed state and displayed. If it is necessary to examine decompression, the number of required prestressing elements is determined by the compensation of the moment of the load combination that is decisive for the verification. Otherwise, the number of prestressing elements is based on a degree of prestressing of 0.6 at $t = \infty$ under the assumption of a loss of 30 % due to shrinkage and creep.

The maximum number of elements in the current [layer](#) which is determined by the prescribed concrete cover and the horizontal minimum distance, is displayed in the status line at the bottom of the screen.

The permissible maximum is 10 layers.

Flag

This option allows you to select whether the distance should refer to the upper or the lower edge.

Distance

The following values are displayed in the status line at the bottom of the screen.

Minimum distance of the first layer: $Y_p(1) = c_{nom} + dp/2$

c_{nom} : nominal thickness of the concrete cover, ▶ see [Basic data](#).

dp : nominal diameter of the prestressing steel elements used

Minimum distance within the layer: $Y_p(i) = Y_p(i-1) + DY_p$

DY_p : vertical minimum distance (to the axis) as per 8.10.1.2

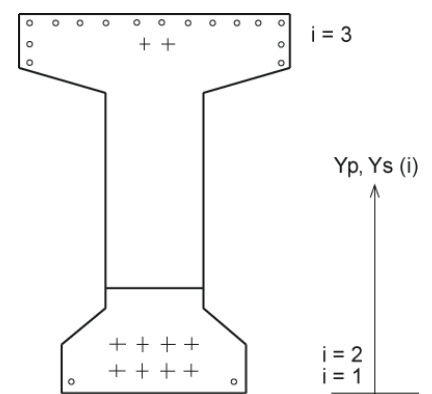

Prestressing

The prestressing should be slightly lower than permissible value stated in 5.10.2.1 ($\sigma < 0.8 \cdot f_{pk}$ and $\sigma < 0.9 \cdot f_{p0.1k}$) to make sure that the stress resistance verification in the prestressing steel will be successful (default is 90 %).

Stripped Insulation

By means of stripped insulation, from a distance X to the right side of the girder up to a distance X from the left side of the girder the pretension can be matched to the behaviour of the loading on the girder. Instead of partly stripped insulated layers (number in each layer > number of stripped bars), you should define a continuous layer and a layer with stripped insulation with the same distances, because the calculated steel stresses are average stresses per layer and will only be correct if you define stripped insulation this way.

If insulation cannot be applied, you can adjust the pretension to the girder loading via a prestressing steel top layer.

Parallel

For a girder with variable height, you can select whether the prestressing steel should run in parallel to the girder top edge or the bottom edge via the corresponding drop-down list (1 = "Lower edge", 2 = "Upper edge").

The unbalanced forces produced by the inclination of the prestressing elements are taken into account in the shear resistance verification.

Prestressing steel definition

The details required for the definition should be taken from



NA_D:	the prestressing steel approval.
NA_A:	ÖNorm B 4758:2011
NA_0 and NA_PN:	pr EN 10138
NA_GB:	BS 5896 [2012]

Type	strand/wire/bar
Surface	intended/ribbed
	NA_D: The use of plain prestressing steel bars is not allowed for pre-tensioning with immediate bond (NCI to 8.10.1.2(1)).
Relaxation	class 1 (strand normal relaxation) class 2 (strand low relaxation) class 3 (hot rolled and tempered bars) EN2, NA_PN, NA_A, NA_GB: according to 3.3.2 NA_D: class 1 = class 2, strands with normal relaxation doesn't exist class 2: as per typical approval for seven-wire strands class 3: as per typical approval for hot-rolled treated bars The values after 1,000 hrs. correspond to /31/, p. 223.
Ap	area of the prestressing element
Ep	modulus of elasticity, strands: 195,000 N/mm ² , wires/bars: 200,000 N/mm ²
fp_{0.1k}	characteristic tensile strength at 0.1 % of the elastic limit
fpk	characteristic value of the tensile strength
α1	coefficient for the kind of tension force application; default value is 1.25 for abrupt application
T	temperature in the prestressing bed, default value is 20 °C, no thermal treatment

$\Delta\sigma_{p,r}(t_0)$	only with NA_D and with thermal treatment: as short-term relaxation anticipates the global loss due to relaxation
lpt	load-transfer length as per eq. 54 with fbpt as per eq. 8.15 and Alfa1 To define the load-transfer length manually, activate the corresponding option.
ld,l / ld,r	the disturbing length can be assumed approximately equal to the cross section height (default setting) at the left end of the girder (ld,l) or the right end of the girder (ld,r). To define the disturbing length manually, activate the corresponding option.
$\gamma_s(PT)$	partial safety factor for the permanent and transient design situations, default as per 2.4.2.4 (1) EN2, NA_D, NA_PN, NA_A, NA_GB: 1.15
$\gamma_s(A)$	partial safety factor for the accidental design situation, default as per 2.4.2.4 (1) EN2, NA_D, NA_PN, NA_A, NA_GB: 1.0.
rsup/rinf	coefficients for the calculation of the characteristic values of the pretension, default as per 5.10.9 (1) EN2, NA_D, NA_PN: rsup=1.05 rinf=0.95 NA_A, NA_GB: rsup=1.0 rinf= 1.0
γ_p,fav	partial safety factor for the pretension, default as 2.4.2.2(1) EN2, NA_D, NA_PN, NA_A: 1.0 NA_GB: 0,9
$\gamma_p,unfav$	partial safety factor for the pretension, default as 2.4.2.2(2) EN2, NA_D, NA_PN, NA_A: 1.0 (immediate bond) NA_GB: 0.9

Reinforcing steel

Click on the  button to display the [definition dialog](#) for the reinforcing steel type.

Basic data	Cross section	Cast-in-place	Assembly	Concrete	Prestressing steel	Reinforcing steel	Recesses	Supports	Text
Longitudinal reinforcement: free selection >>		Stirrup: free selection >>		d = <input type="text"/> mm		Bending design: bottom at x = 7,48 m		req. A_s = 0,00 cm ²	
				Robustness: bottom				req. A_s = 5,43 cm ²	
	Number per layer	Diameter	Area	Flag	Dist.	from xa	to xe	parallel	
1	4	10,0	3,14	1	4,0	0,00	20,20	1	
2	2	14,0	3,08	1	176,0	0,00	20,20	2	
									

Note: The permissible maximum are 10 layers. The user can optionally enter a value that does not comply with the typical diameters listed for that country.

Flag

This option allows you to select whether the distance should refer to the upper or the lower edge.

Distance

The following values are displayed in the status line at the bottom of the screen.

Minimum distance of the first layer: $Y_s(1) = c_{nom} + ds/2$

c_{nom} : nominal thickness of the concrete cover, ▶ see [basic data](#).

ds : diameter of reinforcing steel

Minimum distance within the layer: $Y_s(i) = Y_s(i-1) + DY_s$

DY_s : vertical minimum distance (to the axis) as per 8.2.(2)

Structurally effective area, beginning XA, end XE

The anchorage length should be considered when defining these values. The steel in the area between XA and XE is assumed as fully effective in the verifications. For continuous elements $XA = 0$ and $XE = L_{girder}$, the end anchorage is not verified by the software.

Parallel

For a girder with variable height, you can select whether the reinforcing steel should run in parallel to the girder top edge or the bottom edge via the corresponding drop-down list (1= Lower edge, 2= Upper edge).

Pre-design

The untensioned reinforcement required for the stability, robustness and resistance to bending is roughly calculated on the section with the maximum edge stresses under full loading in the installed state and displayed. The previously defined prestressing reinforcement is taken into account.

Reinforcing steel definition

A selection list allows you to select the type of reinforcing steel in accordance with national rules.

Default values:

NA_A:	B550B	ÖNORM EN 10080 and ÖNORM B 4707
EN2, NA_PN:	B500B	EN 10080
NA_GB:	B500B	BS 4449:2005 A3:2016
NA_D:	B500B	DIN 488

Activating the button you can edit the steel parameters. You can select different types of steel for the untensioned longitudinal reinforcement and the stirrups.

Note: 3.2.2 (2) allows only the use of ribbed reinforcing steel elements.

Es	modulus of elasticity, default value in accordance with 3.2.7 (4) is 200,000 N/mm ²
fyk	characteristic value of the yield strength in N/mm ²
ftk	characteristic value of the tensile strength in N/mm ² (maximum value of the inclined upper branch, also applies to compression loading), Default values: NA_D: ftk,cal= 525 N/mm ² at εud= 25 o/oo EN2, NA_A, NA_PN: ftk= k*fyk at εuk with k= (ft/fy)k minimum values in accordance with the ductility class as per Annex C
εuk	characteristic expansion under maximum load EN2, NA_A, NA_PN: expansion at which ftk is reached calculated expansion limit εud= 0.9 * εuk NA_D: no relevance, εud= 25 o/oo
γs(PT)	partial safety factor for the permanent and transient design situations, reference value in accordance with 2.4.2.4 (1): EN2, NA_D, NA_PN, NA_A: 1.15
γs(A)	partial safety factor for the accidental design situation, reference value in accordance with 2.4.2.4 (1): EN2, NA_D, NA_PN, NA_A: 1.0

Recesses

You can define up to 10 recesses on the web.

They can have a rectangular (type = R) or circular (type = C) shape.

Recesses must not overlap nor intersect with reinforcement layers.

In the current version, no analyses of the inclined main stresses and the shear cover are carried out on the cross sections in the area of recesses. In other verifications, recesses are taken into account under the assumption that expansion is linearly constant over the global cross section. Therefore, the width of a recess should not exceed 60 % of the girder height (/21/, p. 146).

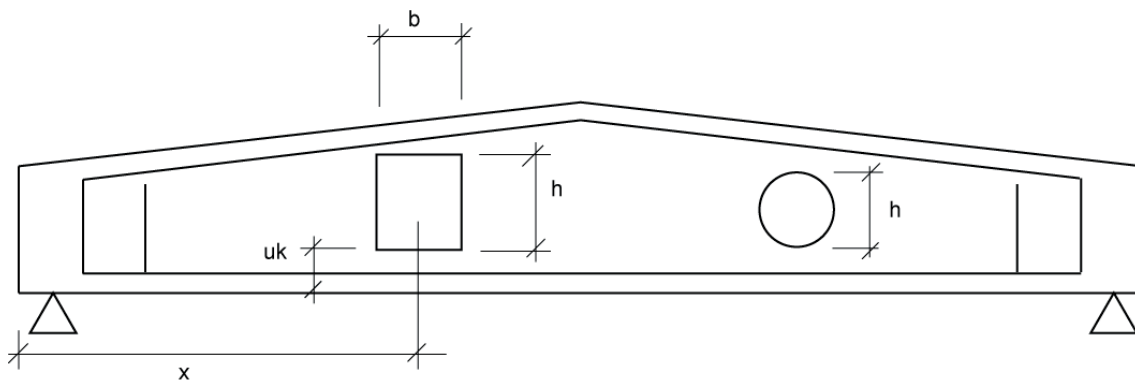

Bearings

In order to avoid that the permissible inclined main stresses and/or the load-bearing capacity of the struts are exceeded, which normally occurs in the surroundings of supports, you can define enlarged bearings by haunches at the girder ends.

Basic data	Cross-section	Cast-in-place	Erection State	Concrete	Prestressing steel	Reinforcing steel	Recesses	Bearings	Remarks																																																																						
<table border="0"> <tr> <td colspan="3">Enlarged bearing</td> <td colspan="3">Bearing:</td> <td colspan="4">Bearing checks:</td> </tr> <tr> <td>left:</td> <td>Length</td> <td>L4= 1.00 m</td> <td>left:</td> <td>ba,l = 0.00 m</td> <td><input type="checkbox"/> Bursting</td> <td>xl= 0.00 m</td> <td colspan="3"></td> </tr> <tr> <td></td> <td>Haunch</td> <td>L5= 0.50 m</td> <td></td> <td><input checked="" type="checkbox"/> direct</td> <td><input type="checkbox"/> Anchorage prestressing steel</td> <td>xr= 19.95 m</td> <td colspan="3"></td> </tr> <tr> <td></td> <td>Width</td> <td>B4= 30.00 cm</td> <td>right:</td> <td>ba,r = 0.00 m</td> <td><input type="checkbox"/> Variation of length</td> <td>dT = -30 K</td> <td colspan="3"></td> </tr> <tr> <td>right:</td> <td>Length</td> <td>L6= 1.00 m</td> <td>right:</td> <td><input checked="" type="checkbox"/> direct</td> <td colspan="5"></td> </tr> <tr> <td></td> <td>Haunch</td> <td>L7= 0.50 m</td> <td colspan="7"></td> </tr> <tr> <td></td> <td>Width</td> <td>B6= 30.00 cm</td> <td colspan="7"></td> </tr> </table>										Enlarged bearing			Bearing:			Bearing checks:				left:	Length	L4= 1.00 m	left:	ba,l = 0.00 m	<input type="checkbox"/> Bursting	xl= 0.00 m					Haunch	L5= 0.50 m		<input checked="" type="checkbox"/> direct	<input type="checkbox"/> Anchorage prestressing steel	xr= 19.95 m					Width	B4= 30.00 cm	right:	ba,r = 0.00 m	<input type="checkbox"/> Variation of length	dT = -30 K				right:	Length	L6= 1.00 m	right:	<input checked="" type="checkbox"/> direct							Haunch	L7= 0.50 m									Width	B6= 30.00 cm							
Enlarged bearing			Bearing:			Bearing checks:																																																																									
left:	Length	L4= 1.00 m	left:	ba,l = 0.00 m	<input type="checkbox"/> Bursting	xl= 0.00 m																																																																									
	Haunch	L5= 0.50 m		<input checked="" type="checkbox"/> direct	<input type="checkbox"/> Anchorage prestressing steel	xr= 19.95 m																																																																									
	Width	B4= 30.00 cm	right:	ba,r = 0.00 m	<input type="checkbox"/> Variation of length	dT = -30 K																																																																									
right:	Length	L6= 1.00 m	right:	<input checked="" type="checkbox"/> direct																																																																											
	Haunch	L7= 0.50 m																																																																													
	Width	B6= 30.00 cm																																																																													

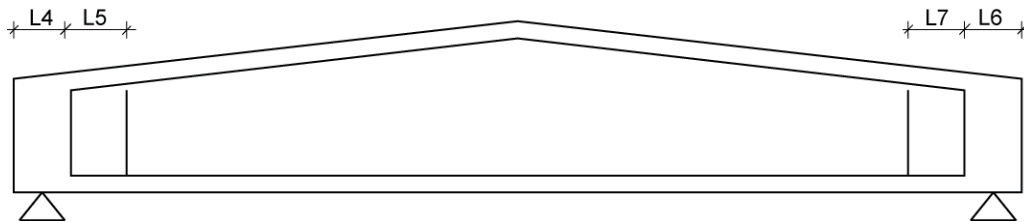

If the width of the reinforcement exceeds that of layers in the top or bottom flange, a new layer is generated at the place where the flange has the width of the reinforcement.

Verifications on the bearings

Tensile splitting	calculation of the tensile splitting reinforcement necessary for the tensioning force transfer.
Prestressing steel anchorage	verification of the resisting tensile force coverage
Changes in length	calculation of the changes in the girder length due to creep, shrinkage and temperature.

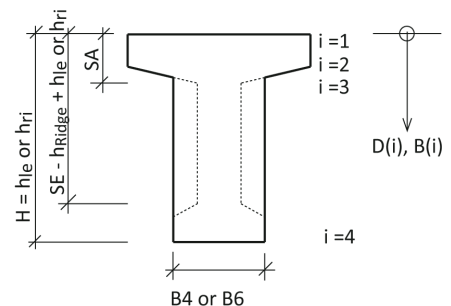

ba,l and ba,r	width of the bearings on the left and the right. The bearing line is assumed in the middle.
Direct support left/right:	when you check this option the border of the area decisive for the shear reinforcement is at the distance d from the support edge. You can also define the border manually in the sections menu. Concentrated loads applying close to the bearings are reduced in the calculation of the shear reinforcement. If any concentrated load applies between the edge of the bearing and the area border, the area border is displaced to the concentrated load at the lowest distance to the support edge.
dT	temperature change included in the calculation of the change in length.
SA	front end of the web
SE	rear end of the web

Loads

All permanent loads (load case G2) and variable loads (load case P) applying in the creep stage "Occupancy/use of prefabricated component" or "Occupancy/use of cast-in-place complement" shall be defined in this section.

Loads											
Sections		Lateral buckling		Optional settings		Remarks					
span	type	Gle	Ple	dist	Gri	Pri	len	factor	from item	Ac-Grp	Sim-Grp
1	1	2	102,00	40,50	4,870			1,00		3	1
2	1	Line load about field length									
3	2	Single load at Dist.									
4	3	Single moment at Dist.									
5	4	Trapez load from Dist. to Dist. + Long									
5	ca li	5	Triangle load about field length								
6	ca ri	6	Trapez load about field length								

Span span designation: span number, left cantilever, right cantilever

Type type of load

- 1 = uniformly distributed line load applying over the entire span length
- 2 = concentrated load applying at the distance a from the left span edge
- 3 = concentrated moment applying at the distance "dist." from the left span edge
- 4 = trapezoidal load applying at the distance "dist." from the left span edge with the length "length"
- 5 = triangular load applying over the span length with Gli/PLi at the distance "dist." from the left span edge
- 6 = trapezoidal load applying over the entire span length
- 0 = changeover to the next span

Gle/Gri characteristic value of the left/right ordinate of the subsequently applying permanent action.

Ple/Pri left/right ordinate.

Characteristic value Q_k of the variable action or design value A_d of the accidental action or design value $A_{Ed} \cdot \gamma_l$ of the action due to earthquake load ($\gamma_l = 1.0$ can be assumed in accordance with /42/ p. 61).

Dist. distance of the left ordinate to the left span edge.

Length distance from the left to the right ordinate.

Factor factor for load ordinates, e.g. for the affected widths.

from item text comment on the origin of actions (6 characters max.).

Ac-Grp action group.

The defined variable loads must be assigned to actions. Press <F5> to display the available actions as per EN 1990 and the selected National Annex.

Sim-Grp You can assign variable loads to groups that always act simultaneously. The loads of a group must be assigned to an action.

Permanent actions over multiple spans

As a standard, permanent actions are combined separately for each span. You can adjust this setting in the [Design settings](#) dialog.

Multiple variable actions

As a standard, all variable actions are assumed to depend on each other, i.e. they are combined to the most unfavourable single action. You can adjust this setting in the [Settings](#) dialog.

Accidental action/action by earthquake

The load ordinate is to be entered as a design value (accidental action A_d , action by earthquake: A_{ed}), an action can consist of several components.

Note: Currently you cannot take multiple independent accidental actions or actions by earthquake into account in one and the same item.

Self-weight

The self-weight is automatically determined prior to each calculation.

Self-weight of prefabricated component G1E, G1M

The self-weight is calculated for the installed state (G1E) or the erecting state (G1M).

Based on the cross section characteristic and the specific weight, a uniformly distributed line load is calculated for girders with parallel flanges, two trapezoidal loads are calculated for girders with saddle or groove and a trapezoidal load is calculated for single-pitch roof girders. The self-weights of the projections and the bearing reinforcements, if any, are taken into account.

Self-weight of cast-in-place concrete GE, UL1, FU1, FU2

Based on the specific weight and the cross section of the cast-in-place concrete complement, a uniformly distributed linear load GE is calculated. If a formwork support was defined, the resulting reduced affected width is taken into account.

Due to the load redistribution after the removal of the formwork support, a line load $UL1 = ((DB1 + DB2) / 2 \cdot \text{continuity factor} \cdot DP \cdot \text{GAMMA}) - GE$ will be added.

DB1, DB2, DP, continuity factor ▶ see the chapter "[Cast-in-place concrete](#)".

The load redistribution after the removal of a girder support is considered via the concentrated loads FU1 and, possibly, FU2, which correspond to the negative supporting forces.

Sections

Number of sections

The girder is examined with the help of a section grid. The user must enter the number of critical sections.

At recesses, the basic grid is refined by additional sections at the beginning, in the middle and the end of the recess. Sections on the left and the right of concentrated loads are added. Over the length of the bearing reinforcement and/or the load-transfer length of the prestressing steel, the section spacing is five times finer.

For each verification parameter, the area to the left and the right of the extreme value determined in the processing of the grid is additionally examined on a grid which is 10 times finer.

All in all, up to 150 sections can be processed sequentially. The number of sections has considerable influence on the computing time as well as on the accuracy in the determination of the critical sections. The number of critical sections should not be too high or too low.

The correct calculation of the deflections in the span and on larger cantilevers requires at least 5 to 10 sections.

Areas not subject to shear resistance verification

With direct supports, the distance $ba / 2 + d$ is set by default, with indirect supports only the distance to the support edge $ba / 2$ is set. See chapter [Bearings](#).

If any concentrated load applies between the edge of the support and the area border, the area border is displaced to the concentrated load at the lowest distance to the support edge.

User-defined: if the assumptions of the automatic calculation are not appropriate, you can set user-defined values.

Maximum span moment

When you activate this option, the section is calculated with the maximum span moment in the installed state.

Select the output on screen in the selection list above (output settings).

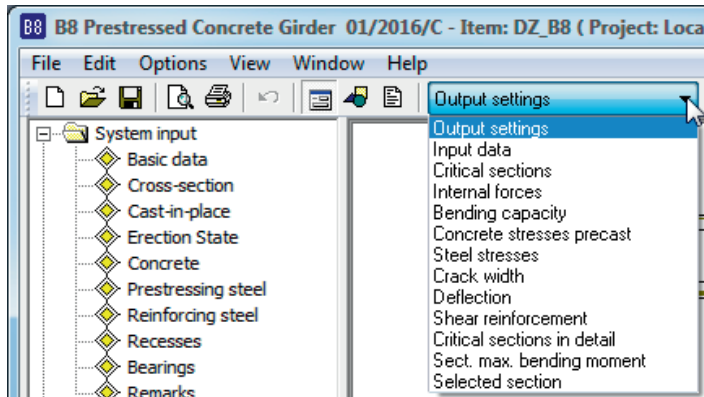

Selected sections

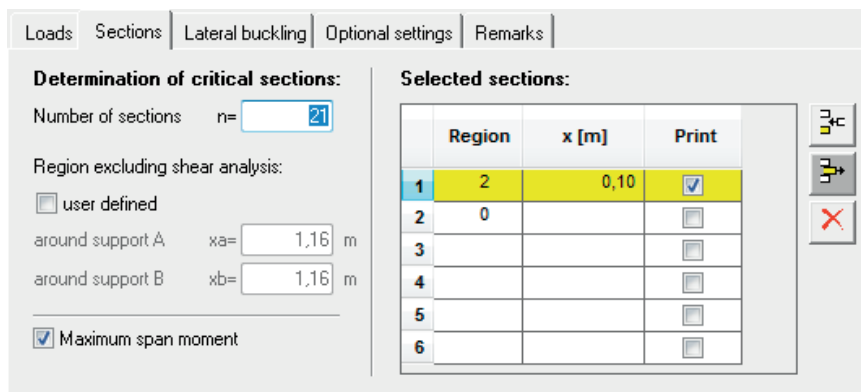

You can examine each section along the girder length, the section spacing x refers to the left edge of the corresponding span.

Region selection of the region in which the section is defined.

1= left cantilever

1 = span

3= right cantilever

$x(m)$ distance of the section to the left region border in [m]

Print Activate the "Print" option to ensure a detailed output of the section.

Lateral buckling

Select the desired method(s) (Stiglat / Mann). The verification of the lateral buckling resistance is only available when an erection system was defined.

Verification of the resistance to lateral buckling in accordance with Stiglat

No additional settings are required.

Verification of the resistance to lateral buckling in accordance with Mann

The untensioned upper reinforcement previously defined is assumed evenly distributed over the width. As the reinforcement for this verification should be placed mainly on the sides, the lateral buckling reinforcement should be defined in this area.

The imperfection on the top flange must be greater than zero, whereas even a negative value can be selected for the bottom flange. If the girder is in an inclined position, this can considerably reduce the lateral buckling stability.

The default settings with $x = L1/2$ are as follows:

Top: $e_t = e_{t1} + e_{t2}$
 $e_{t1} = 0.01 \cdot Z$
 (Inclination through inaccurate erection with
 $Z = 0.9 \cdot D_0$ D_0 is the girder height.
 $e_{t2} = 3$ (as per Mann 1...3)

Bottom: $e_b = 0$

$A_{s,k}$ lateral buckling reinforcement at the flange edge.

d_{buck} ▶ see drawing

All values in [cm].

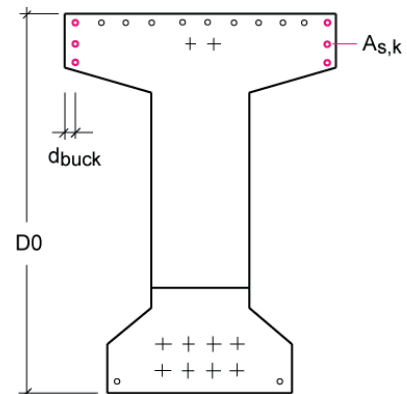

Verification of the lateral buckling stability in the erecting state

With lifting beam check this option if the girder is erected with the help of a lifting beam.

With rope suspension gear

check this option if the girder is erected with the help of a suspension gear.

Hle/Hri: height of the left/right suspension point above the bottom edge of the girder.

α : angle alpha between the erecting rope and the horizontal line (30 to 90 degrees, only in combination with inclined rope suspension)

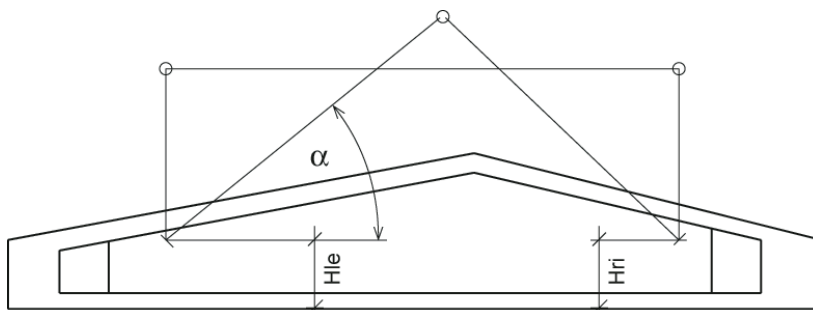

The default setting for Hle and Hri is the corresponding girder top edge. If a suspension lug projects considerably over the girder top edge, you should consider its elasticity via a reduction in height of the suspension points.

It is checked whether the connecting straight line of the suspension points (axis of rotation) runs above the global centre of gravity. If this condition is not satisfied, the girder risks to turn over and an error message is displayed.

Optional settings

Dependencies of actions

- ▶ See Combinations of actions by external loads *in the document B8 Verifications.pdf*

All imposed and live loads are independent:

User-defined setting; each action due to imposed and live loads is combined independently.

Imposed and live loads are dependent each:

User-defined setting; the imposed and live loads are combined to one action each.

All imposed and live loads are dependent:

Default setting; all imposed and live loads are combined to the most unfavourable action.

Do not combine permanent actions per span

User-defined setting, e. g. NA_D NCI to 5.1.3 for a relation of the permanent to the variable loads of $p/g > 0.2$ and for cantilevers of moderate size.

Psi2= 0.5 for snow (Ae)

NA_D: if this option is ticked, the combination coefficient $\psi_2 = 0.5$ is considered for snow instead of $\psi_2 = 0$. This is required by the Construction Codes of some federal states (Baden-Württemberg).

Wind zone III/IV

NA_D: activating this option defines wind action of wind zone III/IV. If wind and snow is combined in regions of wind zone 3 or 4 and if wind is the leading action, snow can be dispensed with as an accompanying action.

Consequence classes

EN2, NA_A, NA_PN: when assigning another consequence class than CC2 (EN 1990 Tab. B.1), the partial safety factors of the actions are modified via an adjusting factor KFI (EN 1990 Tab. B.3).

NA_GB, NA_D: The application is not permitted of consequence classes is not permitted.

Do not consider shear capacity $z < d \cdot 2 \cdot c_{nom}$ (NA_D)

The user can optionally disable this condition to avoid very small cantilevers in combination with thin slabs.

No minimum reinforcement for crack width

Check this option to disable the calculation of the minimum reinforcement.

You should do this only if considerable reactive forces and internal stresses can be excluded (e. g. for statically determined prefabricated components supported without restraints - cf. /35/ p. 5 to 18).

No tensioning force losses resulting from thermal treatment

If the tendons have cooled down to ambient temperature at the time of untying the anchorage after a thermal treatment, tensioning force losses resulting from thermal treatment need not be considered.

NA_D: according to the Professional Association of German Pre-Cast Component Manufacturers (FDB), the conditions for this option are always fulfilled by the technologies applied in Germany.

Permissible deflection

	Global deflection	Deflection after erection
7.4.1	L/250	L/500

Do not consider deflection due to shrinkage

- ▶ See the verification of the deflection resistance in the document [B8_Verifications.pdf](#) (homepage)

Tension stiffening with deflection in the rare load combination

- ▶ See the verification of the deflection resistance in [B8_Verifications.pdf](#) (homepage)

Calculate

Double-click on the corresponding item in the main menu to start the calculation.

If the "Calculate" menu branch is shown in red colour either errors detected during a plausibility check impede the calculation or the results are incomplete due to errors that occurred during the calculation. The error list is displayed on top of the text view even above the defined values.

In the "Edit" menu, you can optionally select whether a calculation should be performed immediately after each change.

Self-weight the self-weight is automatically determined prior to each calculation.



Output

Output of the system data, results and graphical representations on the screen or the printer.

The Output item in the main menu allows you to start the output on a printer or the screen.

Output settings	the dialog offers comprehensive options for the control of the output scope.
Screen	displays the values in a text window on the screen. ▶ See also the chapter "Output of the calculation results"
Printer	starts the output on the printer

Output of the calculation results

The output data are displayed on the screen either as in text view  or a graphical view .

▶ See also the output examples in the document B8 Verifications.pdf (www.frilo.de)

Calculation results in the text view

Click on the text view icon  and subsequently on an option in the selection list (in the menu bar):

You can print the text view by activating the print button  in the toolbar.

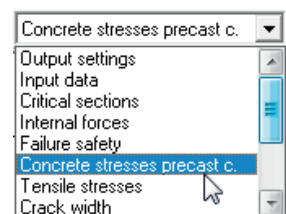

Calculation results in the graphical view

The toolbar below the menu bar allows you to control the output.



Click to a button to display the corresponding result graph.

Description of the buttons from the left to the right.

- System graph
- View with prestressing elements
- Cross section
- Cross section with complement
- M-diagram
- Q-diagram
- Load-bearing capacity in bending
- Concrete edge stresses of prefabricated component
- Concrete edge stresses of complements
- Steel stresses
- Crack width limitation
- Deflections
- Shear cover

You can print the graphic view by activating the "Print" item in the context-sensitive menu which is displayed by clicking with the right mouse button.

Utilization

Activate this item to access the utilization window.

The displayed values are immediately updated after each change.

You can drag the window to any place on the screen with the help of the mouse.

For more information about the displayed values, see the document

B8 Verifications.pdf ▶, chapter Verifications

Click right to display the font size options.

Proofs	exploit. x[m]	
Flexural capacity bottom	0,62	9,92
Flexural capacity top	-----	0,00
Resisting tensile force bottom	1,33	0,10
Resisting tensile force top	-----	0,00
Precast c.: Compr.str. rare LC	0,91	1,48
Precast c.: Compr.str. quasi-perm. LC	6,36	1,48
Precast c.: tensile stress (mounting)	Zu.I	9,72
Precast c.: tensile stress (emplacem.st.)	Zu.II	1,00
Prestressed steel str. q.-perm.LC S	0,83	19,46
Prestr.steel.stress rare LC S	0,71	19,46
Tens. stress in reinforcement	0,18	0,74
Crack width MinAs+ductility reinf. bottom	0,70	19,70
Crack width MinAs+ductility reinf. top	1,51	20,10
Crack width bottom	0,04	9,72
Crack width top	0,07	0,74
Deflection top	0,33	10,10
Deflection bottom	0,01	0,00
Deflection increase (use)	0,34	10,10
Precast c.: Shear reinforce (web)	1,00	1,50
Compressive strut capacity		1,50

Adviser

With a utilization higher than 1.0, you must vary the girder parameters to achieve compliance with the verification limits.

You can access the adviser after the determination of the critical sections. Its features are described below:

Parameters:

P+	increase tensioning force
P-	reduce tensioning force
AI+	insulate prestressing steel
AI-	reduce number of insulations
KS	reduce shrinkage and creep
BSTO	add reinforcing steel on top
BSTU	add reinforcing steel on bottom
BK	select higher concrete class
D0	increase height of cross section
BU	enlarge bottom flange
BO	enlargetop flange
AV	enlarge bearings
XM	change location of the suspension points

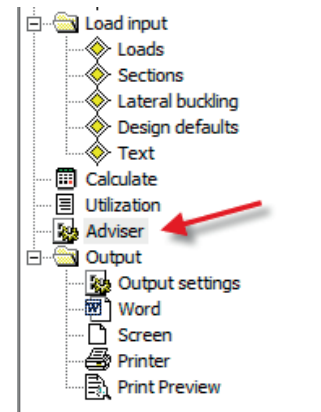

Verification failed	Designation	Parameter variants
Bending resistance on bottom	EtaBu	If EpsS = Epsu: BSTU, P+, AI- If not: BK, D0, BO
Bending resistance on top	EtaBo	If zII < 0: AI+, P-, If not: BSTO, BU, D0, BK, XM
Resisting tensile force coverage on bottom	EtaZu	P+, AI-, BSTU
Resisting tensile force coverage on top	EtaZo	P-, AI+, BSTO, XM
Lateral buckling resist. i.a.w. Stiglat (Ez)	LB(EzS)	BO, BU, D0
Lateral buckling resist. i.a.w. Mann (Ez)	LB(EzM)	BO, D0, BSTU, BSTO
Lateral buckling resist. i.a.w. Stiglat (Mz)	LB(Mz)	BO, BU, D0, XM
EN2: compr. stress in infreq. LC	σ_1	P+, AI-, KS, BK, BO
EN2: compr. stress in quasi-perm. LC	σ_2	P+, AI-, KS, BK, BU
DIN: compr. stress (DZ)	$\sigma_1(t_0)$	P-, AI+, BK, BO
DIN: tensile stress (Ez)	$ \sigma_s $	P-, AI+, BK, BU
DIN: tensile stress (Bz)	wku	P-
	wko	BST(U/O), BK, D0
		BSTU, P+, AI-, KS

DIN: compr. stress (vZ)	Xpu	BSTO, P-, AI+, XM
Prestressing steel stress	Xpo	P+, AI-, KS
Reinforcing steel stress	fo	P-, AI+, XM
Crack width on bottom	fu	P-, BK, D0, earlier installed
Crack width on top	df	P+, BK, KS, D0
Decompression on bottom	VRdmax	BK, D0
Decompression on top		AV, BK, D0, P-
Deflection on top		
Deflection on bottom		
Deflection after erection (utiliz.)		
EN2: strut bearing capacity		

Girder optimization is possible with utilization below 1.0, but difficult to automatize because the different verifications interlock (currently not included in the adviser).

Possible optimization and its prerequisites are lined out below:

Optimization of	If reserves are available for
Reduce reinforcing steel on bottom	EtaBu, EtaZu, Sigs, wku, LB(EzM) EtaBo, EtaZo, Sigs, wko, LB(EzM)
Reduce reinforcing steel on top	EtaBu, EtaZu, Sigs, wku, Xpu, fu
Reduce prestressing steel	EtaBu, EtaZu, wku, Xpu, fu
Reduce D0	EtaBo, EtaZo, wko, Xpo, fo, σ_1 , σ_2 , $\sigma_1(t_0)$, σ_1 , σ_2 , VRdmax, LB (EzS, EzM, Mz)
Reduce B0	σ_1 , σ_2 , $\sigma_1(t_0)$, σ_1 , σ_2 , VRdmax, EtaBu, EtaZu, wku, Xpu, fu
Reduce BO	σ_1 , σ_2 , $\sigma_1(t_0)$, σ_1 , σ_2 , VRdmax LB (EzS, EzM, Mz)
Reduce BU	EtaBo, EtaZo, wko, Xpo, fo, σ_1 , σ_2 , $\sigma_1(t_0)$, σ_1 , σ_2 , VRdmax, LB (EzS, EzM, Mz)

Output settings

You can control the scope of the output by checking/unchecking the desired options.

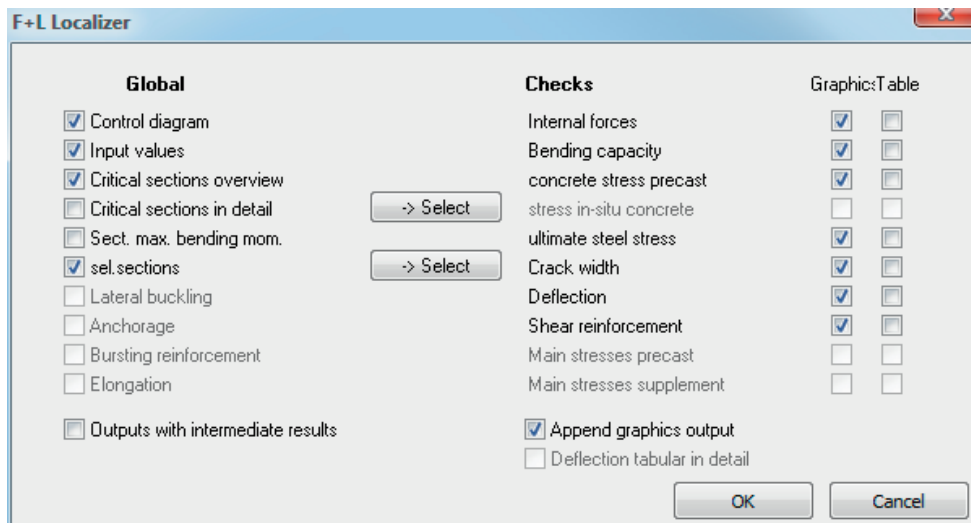

Activating the option "All cross section in detail" adds the following information to the standard scope:

- supporting forces for each component
- internal forces on the selected sections for each component and load case
- expansion states in state II for the verifications in the serviceability limit state on selected sections
- intermediate results for deflection

Output example: You can find an extensive example of an output at www.frilo.eu (B8_FDB-Ref-Eng.pdf).

Text view

Description of the text view options:

Defined parameters

List of all entered data, after the calculation has been completed,

shrinkage strain and creep factor are included (option "Calculation on defined cross section)

Self-weight

Supporting forces (permanent and variable portions, minimum and maximum)

Summary output (essential verifications with utilization)

Critical sections

List of all verifications to be performed in one grid with the critical section, the extreme value and utilization.

Internal forces

Behaviour of the minimum and maximum moments due to external loading

(design situation for the ULS, combinations for the SLS)

Behaviour of the minimum and maximum shear forces

(design situation for the ULS, combinations for the SLS)

Behaviour of the longitudinal force and the moments due to pretension

(t = removal of the anchorage, t = infinite)

Safety against rupture

Bending resistance with longitudinal force on bottom, on top
Resisting tensile force coverage

Concrete stress of prefabricated component

Behaviour of the compressive and tensile concrete stresses in the prefabricated component.

Concrete stress of cast-in-place complement

Behaviour of the compressive and tensile concrete stresses in the cast-in-place complement.

Steel stresses

Behaviour of the maximum stresses in the reinforcing and prestressing steels.

Crack width

Minimum reinforcement, crack width and decompression.
Prefabricated component, on bottom, on top; cast-in-place concrete, if applicable.

Deflection

Deflection behaviour: at the beginning and the end of the storage creep stage.
Deflection behaviour: at the beginning and the end of the occupancy/use creep stage.
Deflection behaviour after erection in the occupancy/use creep stage.

Shear reinforcement

Layout of the shear reinforcement in the web of the prefabricated component.
Layout of the shear reinforcement in the joint.
Behaviour of the bearing capacity of the struts.

Section with max. span moment

Detailed output of the section with the max. span moment.

Selected sections

Detailed output of the selected sections.

Verification of the lateral buckling stability

Output of the enabled verifications of the lateral buckling stability with intermediate results.

Anchorage verification

Output of the anchorage verification of the prestressing reinforcement with intermediate results.

Tensile splitting reinforcement

Output of the verification of the tensile splitting reinforcement with intermediate result.

Changes in length

Calculation results of the changes in the girder length due to creep, shrinkage and temperature.

Selection of the degree of prestressing and suitable reinforcement

Any girder design in concrete or reinforced concrete with any degree of prestressing can be defined.

The limits of the reinforced concrete are attained with great span lengths and high loading.

The transition area from entirely untensioned reinforcement to partial pretension with a prestressing degree of 0 to 0.2 should be avoided, because the requirements for the crack width verification become erratically more severe due to the change from the quasi-permanent to the frequent design situation, the reduction of the permissible crack width to 0.2 mm and the possibly required verification of the decompression resistance. In addition to this, creep and shrinkage, which are calculated in the software in state I, are considerably overestimated for cross sections under permanent loads in state II.

According to /25/ and /26/, the optimum of the required reinforcement is obtained at prestressing degrees of 0.4 to 0.7. This applies only if controlled cracking is permissible (interior component).

If the verification of decompression is required, a higher prestressing degree as with limited pretension might be required.

The prestressing reinforcement should be designed in accordance with /5/ p. 32, in such manner that the moment due to permanent loads (or to the load combination of the decompression verification) is just compensated by the pretension.

Reference literature

- /1/ EC2, T1 (Juni 1992)
- /1a/ EC2, T.1-3, deutsche Entwurfsfassung Juni 1994, BK96 T2
- /2/ Entwurf DIN 1045 02.1996
- /3/ DIN 4227, Teil 1, und Änderung A1
- /4/ DAfStb Anwendungsrichtlinie zu EC2, T1
- /5/ DAfStb, Heft 425, Bemessungshilfsmittel zu EC2, T1
- /6/ DAfStb, Heft 320, Erläuterungen zur DIN 4227
- /7/ Grasser, Kupfer, ...:" Bemessung von Stahl- und Spannbetonbauteilen",BK95, T1, S. 303 ff.
- /8/ Litzner: "Bemessungsgrundlagen nach EC2", BK95, T1, S. 519 ff.
- /9/ Deutscher Betonverein: "Beispiele zur Bemessung von Betontragwerken nach EC2",1994
- /10/ Kupfer:"Bemessung von Spannbetonbauteilen nach DIN 4227", BK94, T1, S. 589 ff.
- /11/ Bieger:"Stahlbeton- und Spannbetontragwerke nach EC2", 1993
- /12/ Zerna:"Spannbetonträger", 1987, S.106 ff.
- /13/ Abelein: "Ein einfaches Verfahren zur Berechnung von Verbundkonstruktionen", Bauingenieur 1987, S.127-132
- /14/ Deneke, Holz, Litzner: "Übersicht über praktische Verfahren zum Nachweis der Kippstabilität schlanker Stahl und Spannbetonträger", Beton- und Stahlbetonbau 1985, 9, S. 238 - 243, 10, S. 274 - 280, 11, S. 299 - 304.
- /15/ Rafla, Die Bautechnik 1975, H.8, S.269-275
- /16/ Stiglat,K...:"Zur Näherungsberechnung der Kipplasten von Stahl- und Spannbetonträgern über Vergleichsschlankheiten", Beton- und Stahlbetonbau 10, 1991, S. 274 - 280.
- /17/ Mann, W.: "Kippnachweis und -aussteifung von schlanken Stahl- und Spannbetonträgern", Beton- und Stahlbetonbau 1976, 2, S.37 - 42.
- /18/ Mann, W.: "Anwendung des vereinfachten Kippnachweises auf T- Profile aus Stahlbeton", Beton- und Stahlbetonbau 1985, 9, S. 235 - 237.
- /19/ Kasperek, K.;Hailer W.: Nachweis und Bemessungsverfahren zum Stabilitätsnachweis nach der neuen DIN 1045, Düsseldorf (Werner 1973)
- /20/ Rossner, W.; Graubner, C.: Spannbetonbauwerke Teil 1, Bemessungsbeispiele nach DIN 4227, Berlin (Ernst & Sohn) 1992
- /21/ Leonhardt, F.: Vorlesungen über Massivbau Teil 3, Berlin (Springer) 1974
- /22/ Rossner, W.; Graubner, C.: Spannbetonbauwerke Teil 2, Bemessungsbeispiele nach Eurocode
- /23/ König, G.; Tue, N.; Pommering, D.: Kurze Erläuterung zur Neufassung DIN 4227 Teil 1, Bauingenieur 1996, S.83-88
- /24/ Geistefeldt; Goris: Tragwerke aus bewehrten Beton nach Eurocode 2, Berlin (Beuth) 1993
- /25/ Bachmann, H.:Teilweise Vorspannung, Erfahrungen aus der Schweiz; Beton- und Stahlbetonbau 2/1980 S.40-44 ./.
- /26/ Kupfer H.: Die Wirtschaftlichkeit als ein Kriterium zur Wahl des Vorspanngrades, Betonwerk+Fertigteiltechnik 5/1986
- /27/ Litzner: "Bemessungsgrundlagen nach EC2", BK96, T1
- /28/ DIN 1045-1 berichtigte Fassung Juli 2001
- /29/ DIN EN206-1
- /30/ Deutscher Ausschuß für Stahlbeton Heft 525
- /31/ Zilch/Rogge, "Bemessung Stahl- und Spannbetonbauteile nach DIN 1045-1", Betonkalender 2002 Teil 1

- /32/ Hegger/Nitsch, „Neuentwicklung bei Spannbetonfertigteilen“, Beton- und Fertigteil-jahrbuch 2000, S.96 ff.
- /33/ Tue/Pierson, „Rissbreite und Nachweiskonzept nach DIN 1045-1“, Beton- und Stahlbetonbau 5/2001
- /34/ DIN 1055-100 Ausgabe März 2001
- /35/ Deutscher Betonverein "Beispiele zur Bemessung nach DIN 1045-1", 2002
- /36/ Backes: "Überprüfung der Güte eines praxisgerechten Näherungsverfahrens zum Nachweis der Kippsicherheit schlanker Stahl- und Spannbetontträger", Beton- und Stahlbetonbau 7/1995 S.176 ff.
- /37/ Reinhardt, "Beton", Betonkalender 2002 Teil 1
- /38/ Curbach/Zilch, "Einführung in DIN 1045-1" Ernst und Sohn 2001
- /39/ Fischer, "Begrenzung der Rissbreite und Mindestbewehrung", Seminarunterlagen DIN 1045-1 Friedrich+Lochner GmbH, Berlin 2001
- /40/ Graubner/Six, "Spannbetonbau" S.F.38 ff., Stahlbetonbau aktuell 2001, Werner Verlag
- /41/ Grünberg, „Grundlagen der Tragwerksplanung, Sicherheitskonzept und Bemessungsregeln für den konstruktiven Hochbau - Erläuterungen zu DIN 1055-100“, Beuth Verlag 2004
- /42/ Dr.Schlüter, „Auslegung von Betonbauten“, Vortrag bei DGEB/DIN Gemeinschaftstagung „Auslegung von Bauwerken gegen Erdbeben - Die neue DIN 4149“, Leinfelden Echterding EN2005
- /44/ Kommentierte Kurzfassung DIN 1045, 2.überarbeitete Auflage, Beuth 2005
- /45/ 2. Berichtigung DIN 1045-1 (2005-06)
- /46/ Berichtigung 1: 2005-05 DAfStb H.525
- /47/ Krüger,Mertzsch,"Beitrag zur Verformungsberechnung von Stahlbetonbauten", Beton- und Stahlbetonbau 1998, Heft 10
- /48/ Rossner, W.; Graubner, C.: Spannbetonbauwerke Teil 3, Bemessungsbeispiele nach DIN 1045-1 und DIN Fachbericht 102, Berlin (Ernst & Sohn) 2005
- /49/ Fingerloos,"Erläuterungen zur praktischen Anwendung der Norm", Betonkalender 2006 Teil 2
- /50/ Neufassung DIN 1045-1 (2008)
- /51/ Deutscher Beton- und Bautechnikverein, Heft 14 (2008)
- /52/ Deutscher Ausschuß für Stahlbeton Heft 600
- /53/ Rossner, W.; Graubner, C.: Spannbetonbauwerke Teil 4, Bemessungsbeispiele nach Eurocode 2, Berlin (Ernst & Sohn) 2012
- /54/ Zilch/Zehetmayer: „ Bemessung im konstruktiven Ingenieurbau nach DIN 1045-1 (2008) und EN 1992-1-1, Springer-Verlag, 2. Auflage 2009
- /55/ Graubner, Six; "Spannbetonbau" S.F.41 ff., Stahlbetonbau aktuell 2012, Werner Verlag
- /56/ Eurocode 2 für Deutschland, kommentierte Fassung Beuth 2012
- /57/ Rossner; „Bruecken aus Spannbeton-Fertigteilen“, Ernst und Sohn 1988