

# Composite Column – V1

FRILO Software GmbH

www.friilo.com

info@friilo.eu

As of 23/06/2017

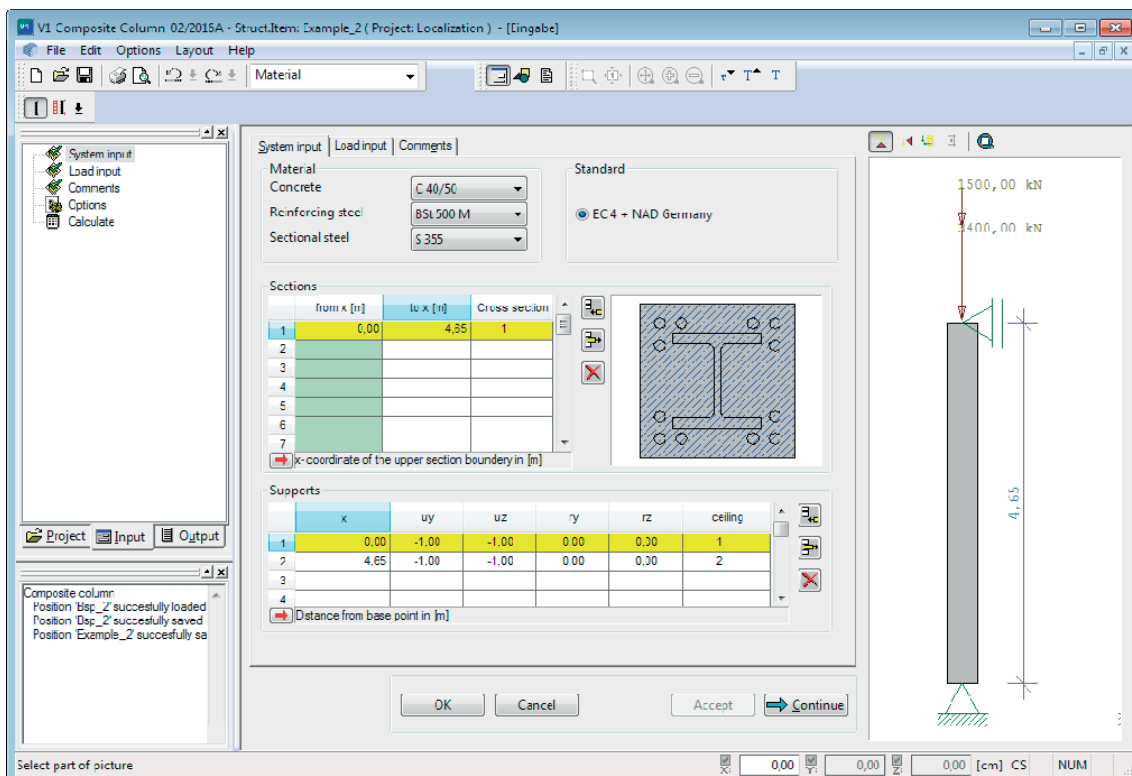



# Composite Column – V1

## Contents

<b>Application options</b>	<b>4</b>
<b>Options/settings</b>	<b>4</b>
<b>Data entry</b>	<b>5</b>
Initial dialog 'Type of column'	5
System of coordinates	5
Definition of the structural system	6
Standard	6
Material	6
Column sections	7
Supports	7
List of cross-sections	8
Definition of the cross-section	9
<b>Definition of the loads</b>	<b>10</b>
Appended hinged column	11
<b>Output</b>	<b>12</b>

Further information and descriptions are available in the relevant documentations:

<a href="#">FDC – Basic Operating Instructions</a>	General instructions for the manipulation of the user interface
<a href="#">FDC – Menu items</a>	General description of the typical menu items of Frilo software applications
<a href="#">FDC – Output and printing</a>	Output and printing
<a href="#">FDC - Import and export</a>	Interfaces to other applications (ASCII, RTF, DXF ...)
<a href="#">FCC</a>	Frilo.Control.Center - the easy-to-use administration module for projects and items
<a href="#">FDD</a>	Frilo.Document.Designer - document management based on PDF
<a href="#">Frilo.System.Next</a>	Installation, configuration, network, database

## Application options

The V1 software application is suitable for the calculation of composite columns based on the simplified method as per DIN 18800 part 5. The software performs verifications of the load-bearing capacity, the serviceability and the fire safety. You can define hinged, cantilever and frame columns or general columns over several storeys.

## Options/settings

The Options window is accessible via the menu option '>> Settings - Composite column' or the main menu (tree on the left) '>> Options'

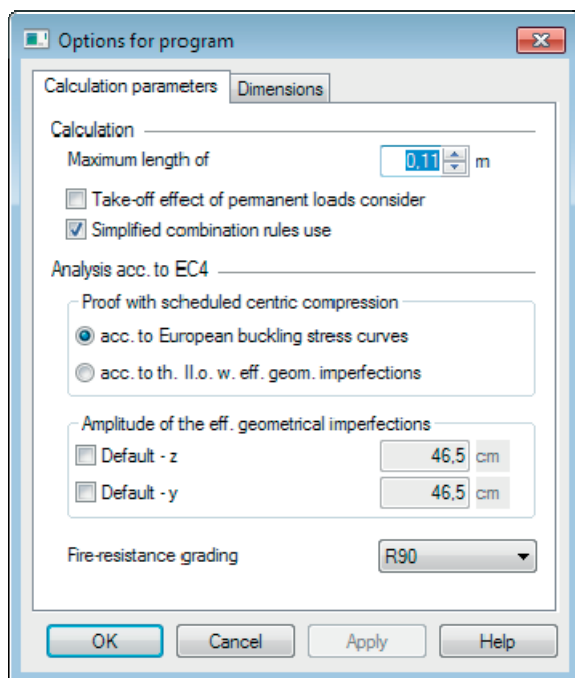

### Calculation parameters

Define fundamental parameters/options for the calculation - see figure.

### Dimensions

This dialog allows the user to select the units for the respective item.

If you save our settings as 'Basic settings', they are applied to every new item.

The 'Reset' button allows you to return to the default settings.

## Data entry

### Initial dialog 'Type of column'

The initial dialog is only displayed when you set up a new item.

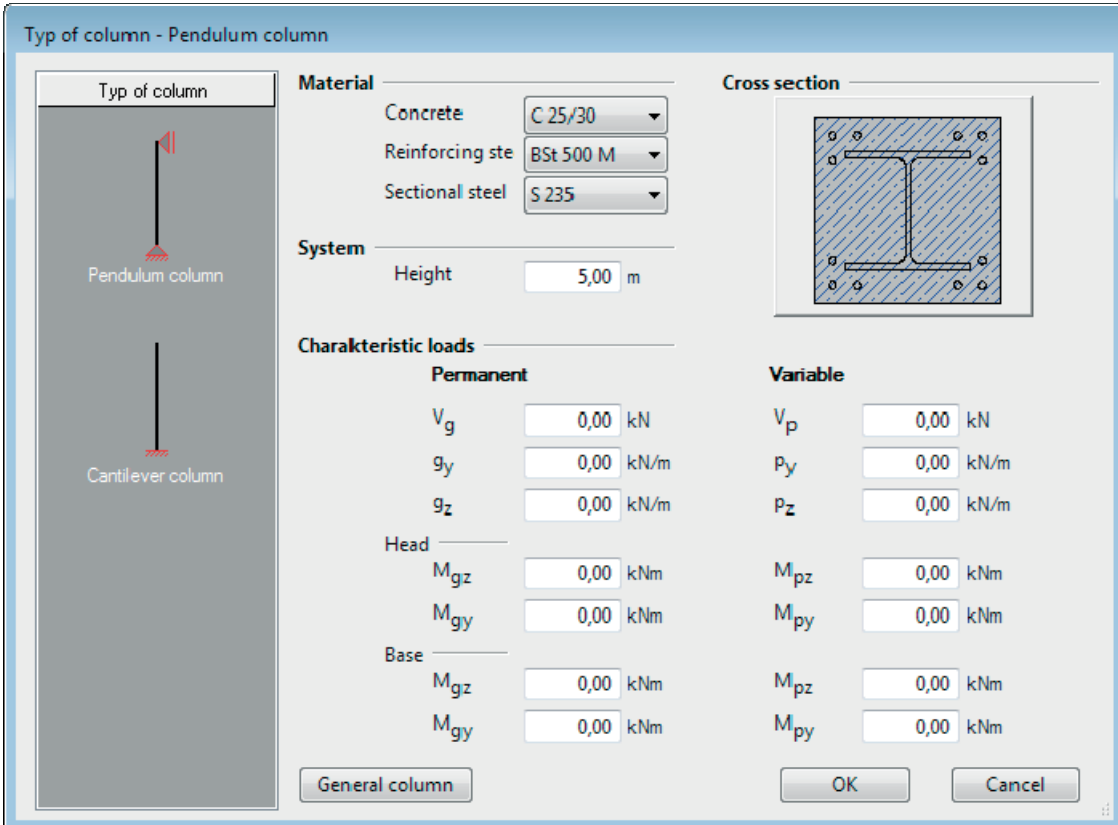

First, select the type of column and define the material, the cross-section, the structural system and the actions subsequently.

You can map many systems in sufficient detail via the options of this dialog.

To apply your settings, confirm them with OK. The dialog for the definition of the structural system is displayed subsequently

### System of coordinates

A right-hand, orthogonal system of coordinates with x as longitudinal axis and y and z as transverse axes is used in V1. The x-axis runs from the bottom to the top, the y-axis from the left to the right and the z-axis from the front to the back. The main task of the system of coordinates is to ensure the definition of the signs for the system, loads, displacements and support reactions.

## Definition of the structural system

This section allows you to specify the [standard](#) to apply, [the material](#), [the column sections](#), [the cross-sections](#) and [the supports](#).

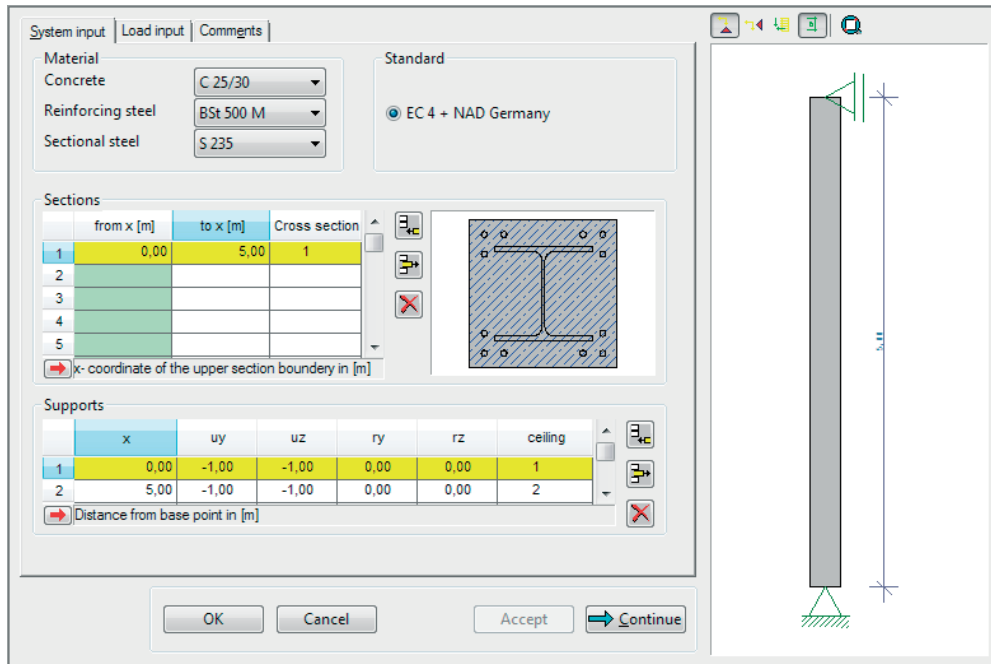

### Standard

EC 4 + NAD Germany

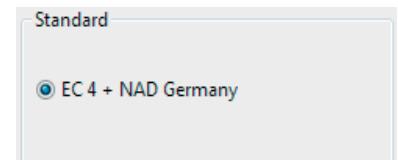

### Material

This section allows you to define the concrete and steel material. The available materials depend on the selected standard.

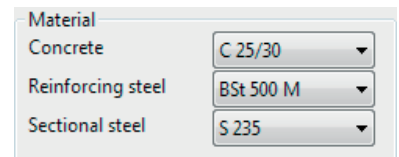

### EC 4 + NAD Germany

The available concrete qualities are displayed in a selection list in accordance with Eurocode 4.

The available strength classes for concrete are C20/25, C25/30, C30/37, C35/45, C40/50, C45/55 and C50/60 in accordance with Eurocode 2. The first value of the class code refers to the compressive cylinder strength, the second specifies the compressive cube strength of the concrete.

## Column sections

You can divide the composite column into different sections. In the current version of the software, you can only define a single cross-section for the entire column.

If you enable the 'Cross-section' column, you can display the [list of available cross-sections](#) by pressing the F5 key.

## Supports

<b>x</b>	distance of the point of support to the base point.
<b>uy, uz</b>	displacement in y or z
<b>ry, rz</b>	torsion around y or z

### Rigid support

The specification of "-1.0" defines a rigid support in the corresponding direction.

### Free support

The specification of "0.0" defines a free support in the corresponding direction.

### Elastic support

An elastic support is defined by specifying a spring stiffness in the corresponding table column. You can set the units for the spring stiffness in the menu 'Options >> Composite Columns Settings >> Dimensions.' The following units are set by default.

Axial force spring:	[kN/cm]
Torsional spring:	[kN * cm / rad]

### Intermediate floor

You can specify whether the position of the support should also be the position of an intermediate floor.

0	no intermediate floor
1	intermediate floor (restraining effect)
2	supporting floor (no restraining effect)

## List of cross-sections

Access: Sections >> Cross-sections column >> F5 key

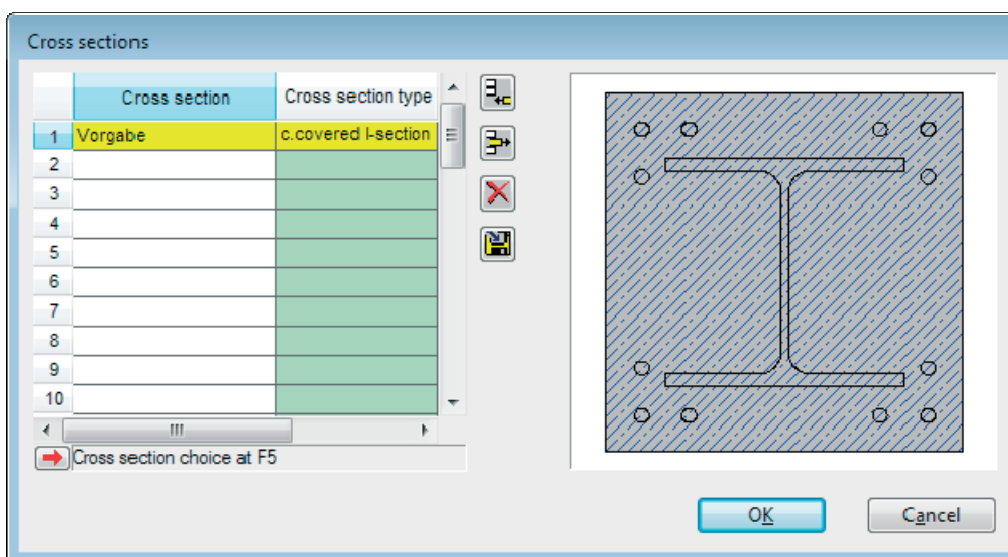

The list of cross-sections allows you to add, edit and delete cross-sections.

In the subsequent dialog 'Select/edit cross-section', accessible via the F5 key, you can define the possible composite cross-sections, e.g. an I-profile cast in concrete.

See also the general description [Select - edit cross section](#).

### Editing the list:

Defining a new cross-section:

- either click to the add button  and confirm your selection by pressing the F5-key or
- double click inside the next empty cell of the "Profile type" column

Editing an existing cross-section:

- either press the F5-key or
- click on the arrow button 

Delete a specific cross-section by clicking on the button 

Delete all cross-sections by clicking on the button 

Import and export cross-sections by clicking on the button 



## Definition of the cross-section

In the dialog 'Select/edit cross-section' the following composite cross-sections are available for selection:

cast-in I-section / concrete-filled I-section / concrete-filled rectangular tube / concrete-filled circular tube.

In the right window section, enter a name and the dimensions of the composite column as well as a longitudinal reinforcement, if applicable.

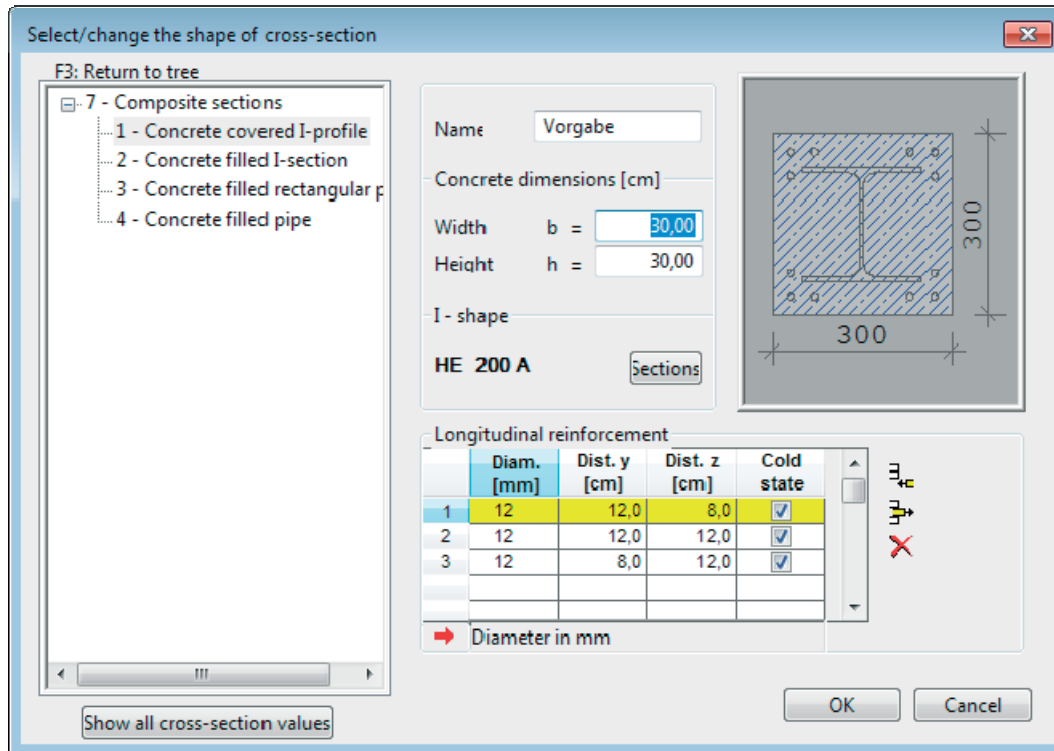

Click on the  button to access the [Select - edit cross section](#) and select the desired I-section, rectangular or circular pipe.

## Definition of the loads

All loads are characteristic actions. Therefore, they are entered without the safety factor  $\gamma$ .

Type	Direction	P1	Distance	P2	Length	ey	ez	Ac-grp	Tog-grp	Alt-grp	Item
1	1	3400,00	4,65			0,0	0,0	99	0	0	Vg
0						0,0	0,0	1	0	0	Vp
1											
2											
3											

### Type = 1: Concentrated load at the distance a

**Orientation:** 1 = load acting in the x-direction  
2 = load acting in the y-direction  
3 = load acting in the z-direction

**P1:** value of the load

**Distance:** distance to the base point

**ey, ez:** eccentricity of a vertical load in the y- or z-direction.

### Type = 2: Concentrated moment at the distance a

**Orientation:** 2 = moment about the y-axis  
3 = moment about the z-axis

**P1:** value of the load

**Distance:** distance to the base point

### Type = 3: Trapezoidal load from a to a + b

**Orientation:** 2 = load acting in the y-direction  
3 = load acting in the z-direction

**P1:** load ordinate at the beginning of the load

**Distance:** distance of the load ordinate to the base point

**P2:** load ordinate at the end of the load

**Length:** length of the line load

### Act. Grp.: Action group

Assignment of a load to an action group as per DIN 1055-100.

### Ccy. Grp.: Concurrency group

Loads that are assigned to the same concurrency group always act simultaneously. These groups have priority over alternative groups.

### Alt. Grp: Alternative group

Loads in an alternative group exclude each other. Example: wind loads from opposite directions.

### Item: Designation of the load

You can assign a free selectable name which is included in the output.

## Appended hinged column

You can define several hinged columns that apply at the same column point. The heights of the hinged columns may differ in a freely selectable manner; the bases need not be at the same height level.

The influence of hinged columns is proportional to the load and inversely proportional to the height.

You can also define negative loads that apply to the hinged columns and negative heights.

The same sign of  $V$  and  $h$  has a destabilizing effect, different signs have a stabilizing effect.

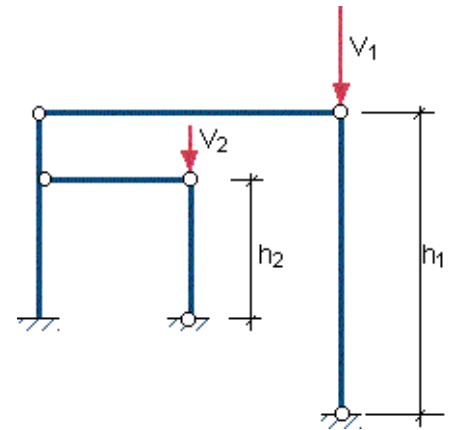

Affixed hinged column					
	x [m]	Direction	Vertical force	H [m]	GammaF
1	3,00	1	50,00	3,00	1,00
2	3,00	1	70,00	3,00	1,00
3	0,00				
4					

**x** point where the hinged column meets the composite column

**Direction** direction of action of the hinged column

1 = y-direction

2 = z-direction

**Vertical force** can be  $\leq 0$

**H** height of the hinged column

**GammaF** enter the safety coefficient to be applied (not enabled in this version of the software).

## Output

Output of system data, results and graphics on the screen or the printer.

The 'Output' item in the main menu allows you to start the output on a printer or the screen. In some program versions, you will be required to enable the output functions by activating the 'Output' tab.

Screen	displays the data in a text window on the screen
Output profile	allows you to adjust the scope of the output to your requirements by checking or unchecking the corresponding options.
<a href="#">Print</a>	starts the output on the printer
Word	if installed on your computer, the text editor MS Word is launched and the data to be put out are transferred. You can edit them in Word as required.

### Note:

By clicking on the printer button  in the upper toolbar, the content of the currently active window (text or graphic) is printed.

Please note that results are only available if a calculation of the structural system was performed before.

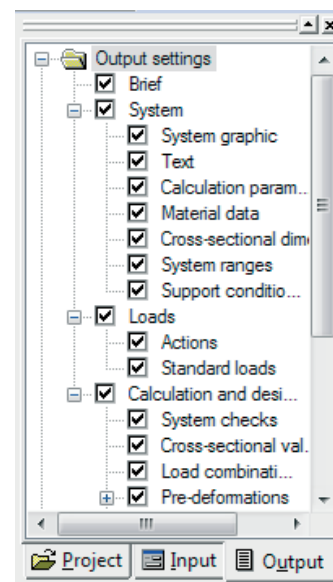

### Contents of the text output

To display a specific section of the output text on the screen, click to the corresponding heading in the selection list (see illustration). The associated text section is displayed.

### Tool bar for the graphics view

First, click on the graphic button  to display the graphic window.

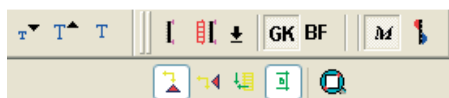

Tooltips for the individual buttons are displayed when you point with the mouse cursor to the button for a short time.

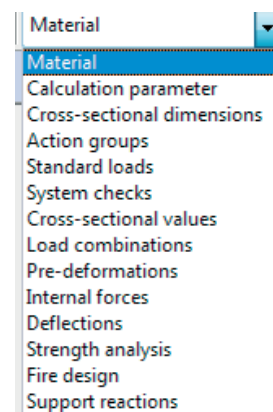

The 'T'-buttons allow you to adjust the font size in the graphics view.

Additional functions:

- Display system graph
- Display load graph in the y-/z-direction
- Results for the basic combination
- Results under fire exposure
- Internal forces in the failure state
- Deformations in the failure state